

Azura

Valve Unifier VU 4.1 Instructions



Document no. V6855

HPLC



Note: For your own safety, read the instructions and follow the warnings and safety information on the device and in the instructions. Keep the instructions for future reference.



Note: In case you require this instruction in another language, please submit your request including the corresponding document number via e-mail or fax to KNAUER.

Support: Do you have questions about the installation or the operation of your instrument or software?

International Support:

Contact your local KNAUER partner for support:

www.knauer.net/en/Support/Distributors-worldwide

Support in Germany

(Austria & Switzerland on case-to-case basis):

Phone: +49 30 809727-111 (workdays 9-17h CET)

Fax: +49 30 8015010

E-mail: support@knauer.net

Publisher: KNAUER Wissenschaftliche Geräte GmbH

Hegauer Weg 38

14163 Berlin

Germany

Phone: +49 30 809727-0

Fax: +49 30 8015010

Internet: www.knauer.net

E-mail: info@knauer.net

Version information: Document number: V6855

Version number: 1.9

Release date: January 26, 2024

Translation of the original edition

The information in this document is subject to change without prior notice. For the latest version of the instructions, visit our website: www.knauer.net/library.



Copyright: This document contains confidential information and may not be reproduced without written consent of KNAUER Wissenschaftliche Geräte GmbH.

© KNAUER Wissenschaftliche Geräte GmbH 2024
All rights reserved.

AZURA® is a registered trademark of
KNAUER Wissenschaftliche Geräte GmbH.

Table of Contents

1. Product information	1
1.1 Intended use	1
1.1.1 Description	1
1.1.2 Operating ranges	1
1.2 Device overview	2
1.2.1 Front view	2
1.3 Rear view	2
1.4 Status display	3
1.5 RFID icon	3
1.6 AZURA® Neo	3
2. Scope of delivery	4
3. General	5
3.1 About these instructions	5
3.2 Signal words	5
3.3 Additional typographical conventions	5
3.4 Legal information	6
3.4.1 Liability limitation	6
3.4.2 Transport damage	6
3.4.3 Warranty conditions	6
3.4.4 Warranty seal	6
3.4.5 Declaration of conformity	6
4. Basic safety instructions	7
4.1 Intended use	7
4.1.1 Operating ranges	7
4.1.2 Foreseeable misuse	7
4.2 User qualification	7
4.3 Operator responsibility	8
4.4 Personal safety equipment	8
4.5 Safety features on the device	8
4.6 Working with solvents	9
4.6.1 General requirements	9
4.6.2 Contamination by health-threatening solvents	9
4.6.3 Avoiding leakage	9

4.7	Specific environments	10
4.7.1	Earthquake-endangered areas	10
4.7.2	Explosive environment	10
4.7.3	Cooling room	10
4.7.4	Wet room	10
4.8	Maintenance, care and repair	10
4.9	Service request form and decontamination report	11
5.	Symbols and signs	12
6.	Unpacking and setup	14
6.1	Operating environment	14
6.2	Unpacking the device	14
6.3	Power supply	15
6.4	Mounting the valve onto the valve drive	16
6.5	Connecting the device to the computer	17
6.5.1	Configuring the LAN settings	18
6.5.2	Connect the devices to the LAN	18
6.5.3	Configuring the router	19
6.5.4	Integrating the LAN into a company network	19
6.5.5	Controlling several systems separately in a LAN	19
6.5.6	Assigning IP addresses	20
6.5.7	Manual/DHCP	20
6.5.8	APIPA	20
6.6	Controlling the drive via the multi-pin connector	21
6.7	Remote control via temporary short circuit (pulse)	22
6.8	Remote control via short-circuit contacts (binary control)	24
6.8.1	Binary code	24
6.9	Ground connection	25
7.	Operation	26
7.1	Switch on and self test	26
7.2	Operating with chromatography software	26
7.3	Operating with the keypad	27
7.3.1	Navigate through menu	27
7.3.2	Changing values	27
7.4	Menu guide	28
7.4.1	Start display	29
7.4.2	Main display	29
7.4.3	Main menu	29
7.4.4	Submenus	30

7.5	Setting the valve position	32
7.5.1	Setting the valve position immediately	32
7.5.2	Setting the valve position after confirmation	32
7.6	Setting the valve drive control	33
7.6.1	LAN control	33
7.6.2	IP Port	33
7.6.3	LAN settings	33
7.6.4	Input	34
7.6.5	Output	35
7.7	Setting to standby	35
7.8	Setting valve position to Home	35
7.9	Replacing rotor seal	36
8.	Functionality tests	37
8.1	Installation Qualification (IQ)	37
8.2	Operation Qualification (OQ)	37
9.	Troubleshooting	38
9.1	LAN	38
9.2	Error messages	39
10.	Maintenance and care	40
10.1	Cleaning the device	40
10.2	Transport	40
11.	Technical data	41
12.	Repeat orders	42
12.1	Valve drive and accessories	42
12.2	Power cable	42
13.	Disposal	43
13.1	AVV-Marking Germany	43
13.2	WEEE registration number	43

1. Product information

1.1 Intended use



Note: Only use the device for applications that fall within the range of the intended use. Otherwise, the protective and safety equipment of the device could fail.

1.1.1 Description

The valve drive AZURA® Valve Unifier VU 4.1 enables automatic valve switching.

The display provides a user friendly operation. Due to its low switching time, the flow path is interrupted only for a very short time, and the pressure peaks are reduced to a minimum.

The valve drive can be operated with one of the available chromatography data systems (OpenLAB® EZChrom Edition, ClarityChrom®, Chromeleon™, PurityChrom® and Mobile Control Chrom), as well with an optional touch display (Mobile Control), via LAN or analog input/output, by which it can be integrated in nearly every LC system.

Valves are identified via innovative RFID technology, which guarantees an easy valve exchange. In addition, the maintenance of the rotor seal exchange is simplified by automatic notifications.

1.1.2 Operating ranges

The device can be used in analytics and purification, among other areas.

1.2 Device overview

1.2.1 Front view

Legend:

- ① Status display (LED)
- ② Selection button
- ③ Confirmation button
- ④ Navigation buttons
- ⑤ Display
- ⑥ Adapter
- ⑦ Valve

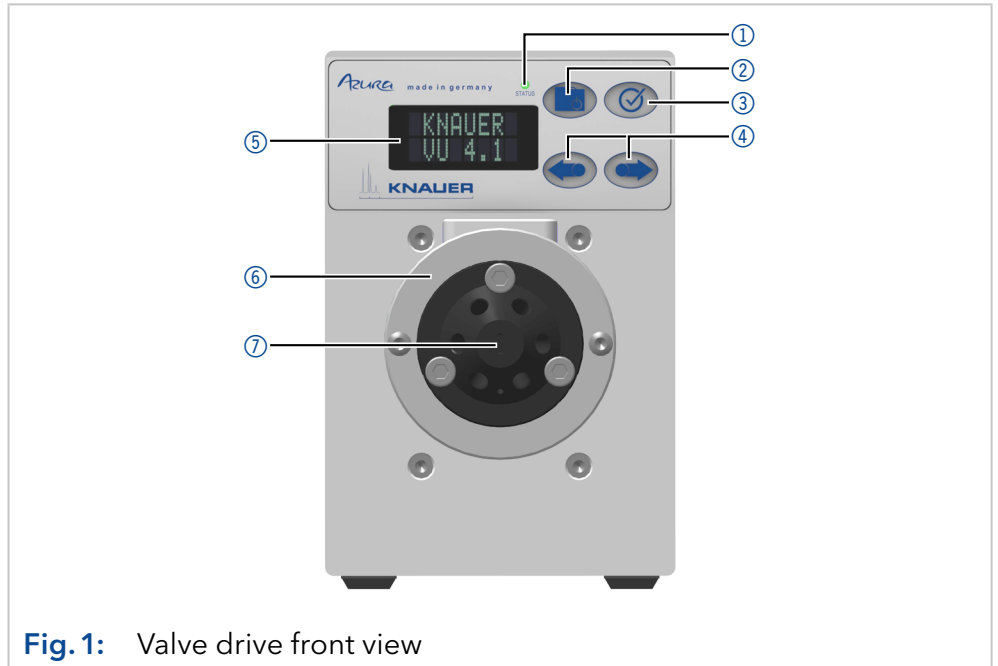

Fig. 1: Valve drive front view

1.3 Rear view

On the rear of the device there are the power-connection bushing, ground for grounding the device, connections for external devices, symbols, warning signs and serial number.

External devices can be connected to the valve drive in three different ways:

- Connected to terminal strip
- Via LAN connector within a network
- Via interface USB (virtual COM port)

Legend:

- ① Serial number and signs (see chapter "5. Symbols and signs" on page 12)
- ② LAN port 1
- ③ LAN port 2
- ④ Terminal strip
- ⑤ Service interface (USB)
- ⑥ Power connection
- ⑦ Ground connection

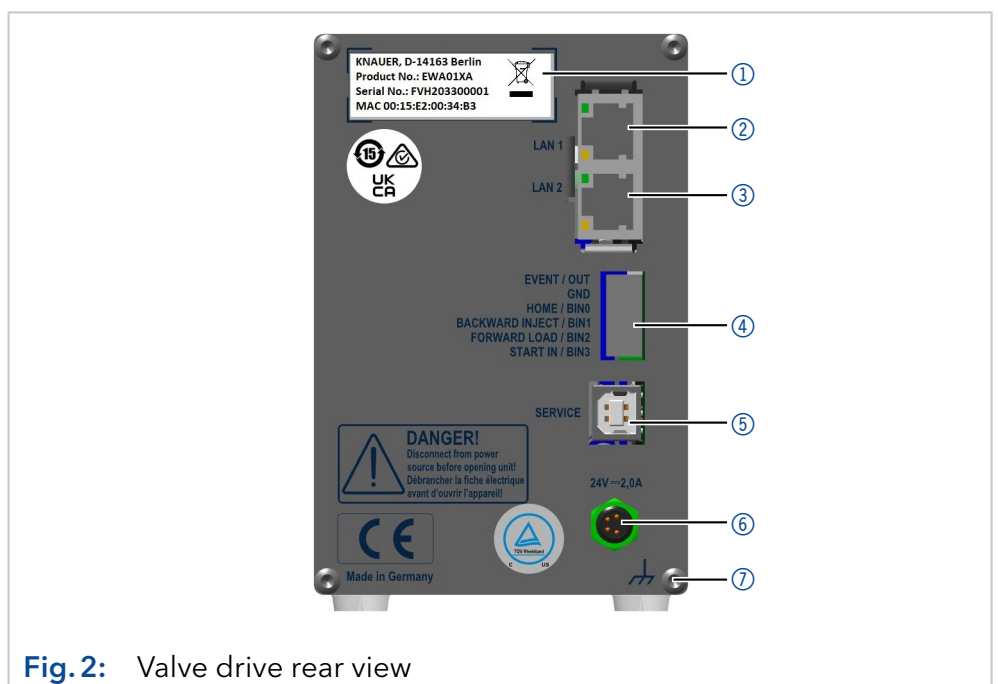





Fig. 2: Valve drive rear view

1.4 Status display

The device status is displayed on the front (see Fig. 1 no. ①). The color of the LED shows the current status.

LED	Status
 grey	Not ready. The valve position must be set to Home.
 green	Blinking: Method in software is paused. Not blinking: Ready
 red	Blinking: Error Not blinking: Fatal error. Contact the Technical Support.
 blue	Standby

1.5 RFID icon

The status of a RFID valve is shown on the display in the main display.



Symbol	Status
	No RFID valve
	RFID tag found
...	RFID tag not found
--	No connection with the valve drive module

1.6 AZURA® Neo

The AZURA® Neo electronic platform features:

- A new microprocessor for faster device performance
- New interfaces: Dual IP stack with switch (for connecting AZURA devices to one another) and LAN stack function, plus USB (internal USB to RS-232) service interface. Both LAN connectors (1 and 2) can be used as interface or switch.

2. Scope of delivery



Note: Only use original parts and accessories made by KNAUER or a company authorized by KNAUER.

- AZURA® Valve Unifier VU 4.1
- Accessory kit AZURA® Valve Unifier VU 4.1
- Instructions (German/English, document no. V6855)
- Power supply 24 V/60 W (input 100 - 240 V)
- Power cable

Valid documents:

- Declaration of conformity

3. General

3.1 About these instructions

These operating instructions enable the safe and efficient operation of the device. The user must have carefully read and understood these operating instructions before starting any work.





The basic prerequisite for safe operation is compliance with all safety instructions (see chapter "4. Basic safety instructions" on page 7). In addition to the safety and warning instructions in these operating instructions, the local accident prevention regulations and the national industrial safety regulations apply.

These operating instructions are an integral part of the device. It must be kept in the immediate vicinity of the device and accessible to the user at all times.

You can download these and other instructions from the KNAUER website: www.knauer.net/library

3.2 Signal words

Possible dangers related to the device are distinguished in personal and material damages.

Symbol	Meaning
	DANGER (red) indicates a highly hazardous situation. If not avoided, it will result in death or serious injury.
	WARNING (orange) indicates a hazardous situation. If not avoided, it could result in death or serious injury.
	CAUTION (yellow) indicates a moderate hazardous situation. If not avoided, it could result in minor or moderate injury.
	NOTICE (blue) is used to address issues which are not related to physical injury.

3.3 Additional typographical conventions

- General equal treatment: When persons are described, this document uses the male grammar form to keep the text easy to read. The form has a neutral sense and speaks to people of any gender in the same way.
- Note: Specific information are prefixed with the word "Note" and an information icon.



Note: This is an example.

3.4 Legal information

3.4.1 Liability limitation

The manufacturer is not liable for the following issues:

- Non-compliance of these instructions
- Non-observance of necessary safety precautions
- Improper use
- Operation of the device by unqualified personnel (see chapter "4.2 User qualification" on page 7)
- Use of non-approved spare parts
- Technical changes by the user such as opening the device and unauthorized modifications
- Violations of General Terms and Conditions (GTC)

3.4.2 Transport damage

The packaging of our devices provides the best possible protection against transport damage. However, check the packaging for transport damage. In case you notice any damage, inform the Technical Support and the shipping company within three workdays.

3.4.3 Warranty conditions

For information on warranty please refer to our general terms and conditions on the website: www.knauer.net/terms

3.4.4 Warranty seal

A blue or orange warranty seal is affixed to some devices.

- A blue seal is used by KNAUER's Manufacturing or Customer Support for devices to be sold.
- After repair, service technicians attach an orange seal onto the identical position.

After repair, the service technician affixes an orange seal in the same place. If unauthorised persons tamper with the device or if the seal is damaged, the warranty will lapse.



3.4.5 Declaration of conformity

The declaration of conformity is enclosed as a separate document with the product and can be obtained online:

www.knauer.net/en/Support/Declarations-of-conformity

4. Basic safety instructions

The device has been developed and constructed in such a way that hazards arising from its intended use are largely excluded. Nevertheless, the following safety instructions must be observed in order to exclude residual hazards.

4.1 Intended use

Only use the device for applications that fall within the range of the intended use. Otherwise, the protective and safety equipment of the device could fail.

4.1.1 Operating ranges

The device is intended to be used indoors for chromatographic applications.

4.1.2 Foreseeable misuse

Refrain from the use of the device for the following purposes or conditions:

- Medical purposes. The device is not approved as a medical product.
- Operating outdoors. Otherwise, the manufacturer does not guarantee the functionality and safety of the device.
- Operation in potentially explosive areas without special and additional explosion protection. Contact the KNAUER Customer Support for more information.

4.2 User qualification

The users are qualified to handle the device if all of the following points apply:

- They have at least a basic knowledge of liquid chromatography.
- They have knowledge about the properties of the used solvents and their health risks.
- They are trained for the special tasks and activities in the laboratory and know the relevant standards and regulations.
- Due to their technical training and experience, they can understand and carry out all the work described in the operating instructions on the instrument and recognize and avoid possible dangers independently.
- Their ability to react is not impaired by the consumption of drugs, alcohol or medication.
- They have participated in the installation of an instrument or training by KNAUER or an authorized company.

If users do not meet these qualifications, they must inform their supervisors.

4.3 Operator responsibility

The operator is any person who operates the device himself or leaves it to a third party for use and who bears the legal product responsibility for the protection of the user or third parties during operation.

The obligations of the operator are listed below:

- Know and follow the applicable work safety regulations
- Identify hazards arising from the working conditions at the place of use in a risk assessment.
- Set up operating instructions for the operation of the device.
- Regularly check whether the operating instructions correspond to the current status of the regulations.
- Clearly regulate and specify responsibilities for installation, operation, troubleshooting, maintenance and cleaning and set clear rules
- Ensure that all personnel who work with the device have read and understood these operating instructions
- Train the personnel who work with the device at regular intervals and inform them about the dangers.
- Provide the necessary safety equipment to the employees working with the unit (see section below).

4.4 Personal safety equipment

The protective measures required in the laboratory must be observed and the following protective clothing worn during all work on the device:

- Safety glasses with side protection
- Protective gloves in accordance with the prevailing ambient conditions and used solvents (e.g. heat, cold, protection against chemicals)
- Lab coat
- Personalised protective safety equipment which is specified in the particular laboratory.

4.5 Safety features on the device

- Power switch: Devices of the AZURA® L series may be switched off using the power switch (toggle switch on the back side of housing) at any time, this causes no damage to the device. To switch off devices of the AZURA® S series, remove the plug from the power socket.
- Front cover: Devices of the AZURA® L series have a front cover as a splash protection for the user
- Leak tray: Devices of the AZURA® L series have a leak tray on the front side. The leak tray collects leaking solvents and protects components from potential damage caused by discharging liquid.
- Lamp: For the detectors AZURA DAD 2.1L, DAD 6.1L und MWD 2.1L, the lamp switches off automatically when the cover is opened.

4.6 Working with solvents

4.6.1 General requirements

- The user is trained for handling different solvents.
- Note recommended solvents and concentrations in these instructions in order to avoid personal injury or damage to the device. For example, certain chemicals may cause PEEK capillaries to swell or burst.
- Note that organic solvents are toxic above a certain concentration. For handling hazardous solvents see the following section.
- Mobile phases and samples may contain volatile or combustible solvents. Avoid the accumulation of these substances. Ensure good ventilation of the installation site. Avoid open flames and sparks. Do not operate the instrument in the presence of flammable gases or vapors.
- Only use solvents which do not self-ignite under given conditions. This applies especially to the use of a thermostat where liquids could get onto hot surfaces in the interior.
- Degas solvents before use and observe their purity.

4.6.2 Contamination by health-threatening solvents

- Contamination with toxic, infectious or radioactive substances poses a hazard for all persons involved during operation, repair, sale, and disposal of a device.
- All contaminated devices must be properly decontaminated by a specialist company or the operating company before they can be recommissioned, repaired, sold, or disposed (see chapter "4.9 Service request form and decontamination report" on page 11).

4.6.3 Avoiding leakage

Risk of electrical shock or short circuit if solvents or other liquids leak into the interior of the device. You can avoid a leakage through the following measures:

- Tightness: Visually check the device or system regularly for leaks.
- Solvent tray: The use of a solvent tray prevents liquids get from the bottles into the inside of the device.
- Eluent lines: Install capillaries and hoses in such a way that, in case of a leak, liquids cannot get into the interior of the devices underneath.
- In case of leakage: Switch off the system. Only take the device into operation if the cause of the leak has been resolved.

4.7 Specific environments

4.7.1 Earthquake-endangered areas

In earthquake-endangered areas, do not stack more than 3 devices on top of each other. Otherwise there is risk of injury due to falling devices or loose parts.

4.7.2 Explosive environment

Never use the system in potentially explosive atmospheres without appropriate protective equipment. For more information, contact the KNAUER Customer Support.

4.7.3 Cooling room

You may operate the device in a cooling room. To prevent condensation, note the following instructions:

- Allow the device to acclimatize for min. 3 hours before taking it into operation.
- After taking into operation, the device should stay switched on.
- Avoid temperature fluctuations.

4.7.4 Wet room

The device must not be operated in wet rooms.

4.8 Maintenance, care and repair

- Avoiding electric shock: Before performing any maintenance and service work, disconnect the device from the power supply.
- Tools: Use only tools recommended or prescribed by the manufacturer.
- Spare parts and accessories: Only use original parts and accessories made by KNAUER or a company authorized by KNAUER.
- PEEK fittings: Use PEEK fittings only for a single port or brand-new PEEK fittings in order to avoid dead volume or not exactly fitting connections.
- Column care: Follow KNAUER or other manufacturer's instructions on caring for the columns (see www.knauer.net/columncare)
- Used capillaries: Do not use any used capillaries elsewhere in the system in order to avoid dead volumes, not exactly fitting connections and spreading contamination.
- Safety features: The device may only be opened by the KNAUER Customer Support of KNAUER or any company authorized by KNAUER (see chapter "3.4.1 Liability limitation" on page 6).
- For more information visit the KNAUER website: www.knauer.net/hplc-troubleshooting

4.9 Service request form and decontamination report

Devices which are shipped without the completed document "Service request form and decontamination report" will not be repaired. If you would like to return a device to KNAUER, make sure to enclose the completed document: www.knauer.net/servicerequest

5. Symbols and signs

The following symbols and signs can be found on the device:

Symbol	Meaning
	Electric shock hazard. Failure to observe this warning may result in loss of life, serious injury or damage or destruction of the device.
	Electrostatic discharge hazard. Damages to system, device, or sensitive electronic components can occur.
	A warranty seal is affixed to some devices. For more information (see chapter 3.4.4 on page 6).
	The device is covered by the Waste Electrical and Electronic Equipment Directive (WEEE Directive). It may not be disposed of as unsorted municipal waste and must be collected separately. For more information (see chapter 13 on page 43).
	The device fulfills the product specific requirements of European directives.
	The device complies with the product-specific requirements of the United Kingdom.
	The device has successfully passed the TÜV tests for quality and safety. The TÜV Germany is a nationally recognized testing agency (NRTL) in Canada and the USA.
	The device complies with the Australian EMV regulations.

Symbol **Meaning**



The device can be used for 15 years according to its intended use before there is a risk that the contained substances may escape and thereby pose a risk to the environment and health.

部件名称	有毒及危险物质或元素					
	铅	汞	镉	铬(VI)	多溴联苯	多溴二苯醚
印刷电路板	O	O	O	O	O	O
机电部件	O	O	O	O	O	O
电缆和电线	O	O	O	O	O	O
金属部件	X	O	O	O	O	O
塑料部件	O	O	O	O	O	O
电池	O	O	O	O	O	O
显示	O	O	O	O	O	O
<p>O = 表示部件中所有同质金属中的有毒和危险物质含量低于SJ/T 11363-2006中描述的浓度极限要求。(表示部件中所有同质金属中的有毒和危险物质含量低于SJ/T 11363-2006中描述的浓度极限要求。*)</p> <p>X = 表示部件中所有同质金属中的有毒和危险物质含量超过SJ/T 11363-2006中描述的浓度极限要求。(表示部件中所有同质金属中的有毒和危险物质含量超过SJ/T 11363-2006*中描述的浓度极限要求。*)</p>						

Part Name	toxic and hazardous substances or elements					
	Pb	Hg	Cd	Cr(VI)	PBB	PBDE
PCB	O	O	O	O	O	O
Electromechanical parts	O	O	O	O	O	O
Cables & wires	O	O	O	O	O	O
Metal Parts	X	O	O	O	O	O
Plastic parts	O	O	O	O	O	O
Batteries	O	O	O	O	O	O
Display	O	O	O	O	O	O
<p>O = Indicates that the content of the toxic and hazardous substances in all homogenous Materials of the part is below the concentration limit requirements as described in SJ/T 11363-2006. (Indicates that the content of the toxic and hazardous substances in all homogenous Materials of the part is below the concentration limit requirements as described in SJ/T 11363-2006.*)</p> <p>X = Indicates that the content of the toxic and hazardous substances in all homogenous Materials of the part is exceeds the concentration limit requirements as described in SJ/T 11363-2006. (Indicates that the content of the toxic and hazardous substances in all homogenous Materials of the part is exceeds the concentration limit requirements as described in SJ/T 11363-2006.*)</p>						

6. Unpacking and setup

This chapter describes all preparatory steps prior to start-up.

6.1 Operating environment

Only if the requirements for ambient conditions of the operating environment are met, can the intended use be ensured. You will find the ambient conditions under Technical Data.

NOTICE

Device defect

The device overheats at exposure to sunlight and insufficient air circulation. Device failures are very likely.

- Set up the device in such a way that it is protected against exposure to direct sunlight.
- Leave room for air circulation: See paragraph „space requirements“.

Space requirements

- At least 5 cm, if there is another device on one side.
- At least 10 cm, if there are devices set up on both sides.

General requirements

- Position the device on a level surface.
- Protect the device against direct exposure to sunlight.
- Set up the device at a location not exposed to air drafts (A/C systems).
- Do not set up the device near other machines that cause floor vibrations.
- Avoid sources of high frequencies near the device. High-frequency sources may compromise measuring values.

6.2 Unpacking the device

Prerequisite

- Check packaging for damage caused during transportation. If necessary, put forward any claim for damages to the carrier.

Tool

- Utility knife

⚠ CAUTION

Bruising danger

Damage to the device by carrying or lifting it on protruding housing parts. The device may fall and thus cause injuries.

- Lift the device only centrally on the side of the housing.

Process

1. Set up the package in such a way that you can read the label. Using the utility knife, cut the adhesive tape and open the packaging.
2. Remove the foam insert. Take out the accessory kit and the manual.
3. Open the accessory kit and check the scope of delivery. In case any parts are missing, contact the Technical Support.

4. Clasp the device from below, lift it out of the packaging and place it on its feet. Do not hold onto the front cover.
5. Check the device for signs of damage that occurred during transport. In case you notice any damage, contact the Technical Support.
6. Place the device in its site of operation and remove protective foil.

Next steps Store packaging and keep the included packing list for repeat orders.

6.3 Power supply

Use only the enclosed power cable to connect the device to the power supply to make sure that the specifications stated in Technical Data are met. But check beforehand to use power cables which are admitted for use in your country. Replace defective power cables only with accessories from KNAUER. Do not replace detachable power cables with different cable types.

NOTICE

Electronic defect

Electronic hazard when using an identically constructed power adapter from another manufacturer.

→ Only use spare parts and accessories from KNAUER or a company authorized by KNAUER.

- Prerequisites**
- The electrical power supply at the installation site must be connected directly to the nearest main power line.
 - The power must be free from ripple, residual current, voltage peaks and electromagnetic interference.
 - The connectors for the mains voltage are grounded accordingly.
 - The device receives sufficient power with reserve capacity
- Power Plug**
- The device is intended for use with AC power networks of 100 - 240 V.
 - Make sure that the power plug on the power supply (wall mounted socket or power strip) is always accessible, so that the device can be disconnected from the power supply.

6.4 Mounting the valve onto the valve drive

Tools: Screwdriver, TX 10



Note: The coupling ⑥ of the valve ① has to be in HOME position for the valve to be mounted correctly (see Fig.3 on page 16).

Make sure that the valve is correctly aligned during installation:

The valve ① has an RFID chip ②. The RFID chip must face upwards during assembly (so that it subsequently faces the RFID sensor ⑤ on the valve drive). There is also an approx. 2 mm deep blind hole ⑨ on the stator of the valve. Opposite on the valve drive ④, there is a corresponding pin ⑧ that fits into blind hole.

The shaft of the valve's rotor is flattened at the end. Next to the flattening, there is a pin in the shaft (90° to the axis of rotation of the shaft). The pin must be in horizontal position when the valve is mounted and the flattening must point to the right (as the figure shows).

For correct mounting of the valve, the coupling must be in HOME position (see Fig.3 on page 16), the receptacle ⑥ for the pin ⑩ must be in horizontal position. The small pin ⑦ on the receptacle ⑥ must be on the right.

The valve can only be mounted if the components are arranged as described above.

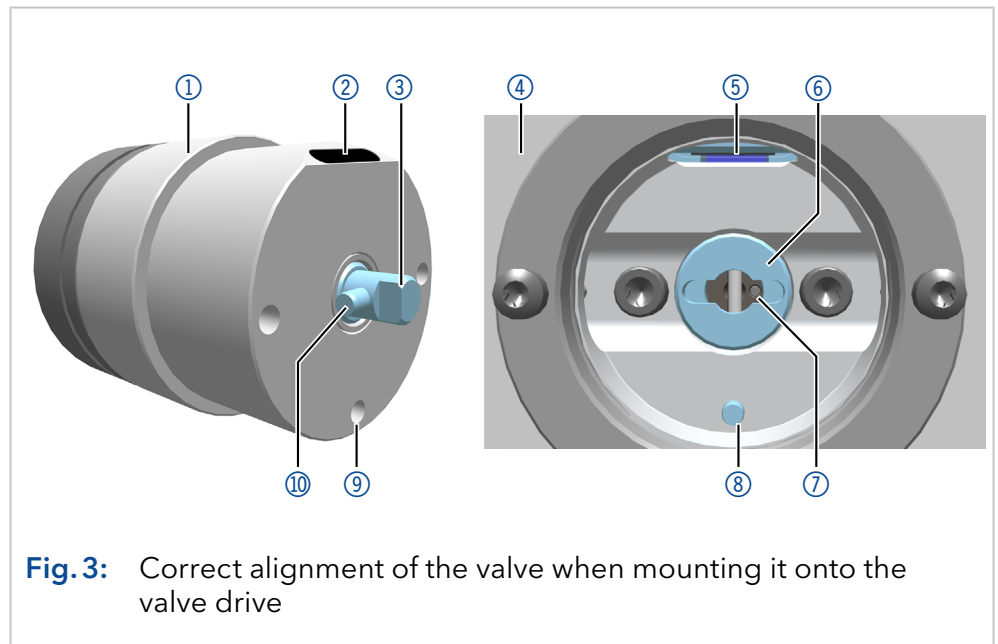

Process

1. Loosen the screws ① of the adapter ② until resistance using the screwdriver.

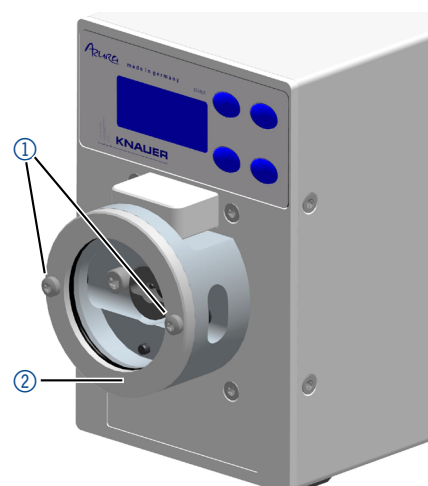
Figure**Fig. 4:** Loosening the screws

2. Mount the valve ④ onto the drive coupling ③. The screw between the port 1 and port 6 of the valve has to point up.
3. Using a torque wrench, tighten the screws ① of the adapter ② (Fig. 4) to a torque of 1 Nm.

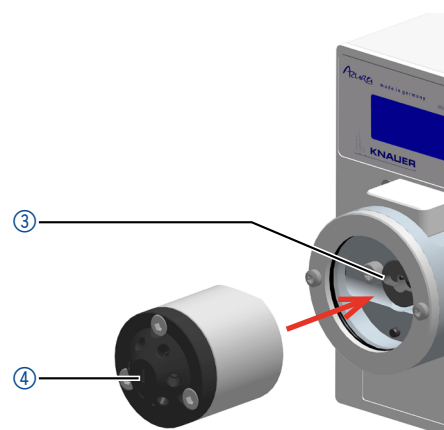
**Fig. 5:** Mounting the valve

6.5 Connecting the device to the computer



Note: IHPLC devices made by KNAUER work only with IP addresses which are assigned via IPv4. IPv6 is not supported.

This section describes how to set up an HPLC system in a local area network (LAN) and how a network administrator can integrate this LAN into your company network. The description applies to the operating system Windows and all conventional routers.

To set up a LAN, we recommend to use a router. That means the following steps are required:

- Process**
1. On the computer, go to the control panel and check the LAN properties.
 2. Hook up the router to the devices and the computer.

3. On the computer, configure the router to set up the network. Install the chromatography software from the data storage device.
4. Switch on the device and run the chromatography software.

6.5.1 Configuring the LAN settings

The LAN uses only one server (usually the router) from which the devices automatically receive their IP addresses.

Prerequisites

- In Windows, power saving, hibernation, standby, and screen saver must be deactivated.
- In case you use an USB-to-COM box, the option "Allow the computer to turn off this device to save power" in the Device Manager must be deactivated for all USB hosts.
- For all LAN devices: For the network adapter, the following option in the Device Manager must be deactivated: "Allow the computer to turn off this device to save power".

Process

1. In Windows open the **Network and Sharing Center**.
2. Double-click on **LAN Connection**.
3. Click on the button **Properties**.
4. Select **Internet Protocol version 4 (TCP/IPv4)**.
5. Click on the button **Properties**.
6. Check the settings in the tab **General**. The correct settings for the DHCP client are:
 - a) **Obtain IP address automatically**
 - b) **Obtain DNS server address automatically**
7. Click on the button **OK**.

6.5.2 Connect the devices to the LAN

A router ② has several LAN ports ③ and one WAN port ④ that can be used to integrate the LAN into a wide area network (WAN), e.g. a company network or the Internet. In contrast, the LAN ports serve to set up a network from devices ① and a computer ⑤. To avoid interference, we recommend operating the HPLC system separately from the company network.

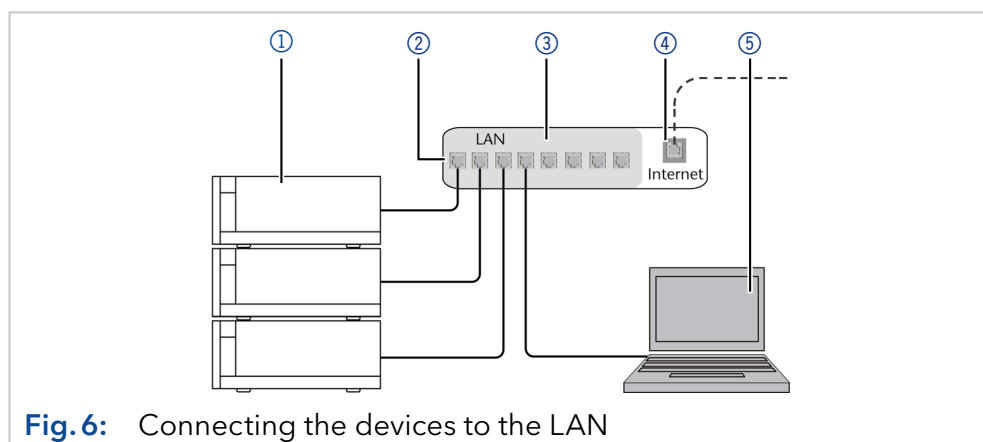

Fig. 6: Connecting the devices to the LAN

You will find patch cables for each device and the router in the accessories kit. To connect the router to a WAN, an additional patch cable is required, which is not part of the scope of delivery.

- Prerequisites**
- The computer has been switched off.
 - There is a patch cable for each device and the computer.
- Process**
1. Use the patch cable to connect the router and the computer. Repeat this step to connect all devices.
 2. Use the power supply to connect the router to the mains power system.

6.5.3 Configuring the router

The router is preset at the factory. You find information about IP address, user name and password in the router instructions: www.knauer.net/router.

- Process**
1. To open the router configuration, start your Internet browser and enter the IP address (not for all routers).
 2. Enter user name and password.
 3. Configure the router as DHCP server.
 4. In the router configuration, check the IP address range and make changes if necessary.



Note: If the IP address range has been changed, it is necessary to make a note of it.

- Result**
- Once the router has assigned IP addresses to all devices, the chromatography software can be used to remotely control the system.

6.5.4 Integrating the LAN into a company network

A network administrator can integrate the LAN into your company network. In this case you use the WAN port of the router.

- Prerequisites**
- There is a patch cable for the connection.
- Process**
1. Check that the IP address range of the router and of the company network do not overlap.
 2. In case of an overlap, change the IP address range of the router.
 3. Use the patch cable to connect the router WAN port to the company network.
 4. Restart all devices, including the computer.

6.5.5 Controlling several systems separately in a LAN

Devices connected to a LAN communicate through ports, which are part of the IP address. If more than one HPLC system is connected to the same LAN and you plan on controlling them separately, you can use different ports to avoid interference. Therefore, the port number for each device must be changed and this same number must be entered into the device configuration of the chromatography software. We recommend to use the same port number for all devices in the same system.



Note: The port is set to 10001 at the factory. You must use the same numbers in the device configuration of the chromatography software as in the device, otherwise the connection fails.

- Process**
1. Find out port number and change it on the device.
 2. Enter the port number in the chromatography software.

Result The connection is established.

6.5.6 Assigning IP addresses

To assign an IP address to the device, it must be connected to a LAN network. The two LAN ports of the device can be connected to the PC and/or to another device as desired. Note that the other device can in turn be connected to a third device, and so on, so that you can connect several devices in succession (cascade). Never connect both ports to the same PC/device or close a ring. At the end of the chain, you can also connect a device with only one LAN port.

All devices connected in this way can be controlled individually via the PC if they have an IP address from the same network range as the PC. However, none of the devices in this chain may be switched off, otherwise communication will be interrupted.

Via Mobile Control you can either assign the IP address manually or set the device to DHCP (obtain dynamic IP address). Furthermore, all devices with AZURA Neo can obtain an IP address via the „routerless“ APIPA service.

6.5.7 Manual/DHCP

The IP address can be assigned via valve drive display. In the submenu “Drive Setup”, you can assign whether the LAN control is set to manual or via DHCP. For the manual control, the IP port and the IP address, netmask and gateway must be set. For more details, (see chapter “7.6 Setting the valve drive control” on page 33).

6.5.8 APIPA

APIPA is a service that allows devices to obtain a dynamic IP address even without a DHCP server in the network. The AZURA Neo platform from KNAUER supports APIPA. The device must be set to DHCP for this. If no DHCP server responds, the APIPA implementation ensures that the device gives itself a random IP address from the IP address range reserved for APIPA (169.254.x.x). This ensures that 2 devices do not use the same IP address. This process can take several minutes. At each reboot the device will use a different APIPA IP address.

Since Windows also supports APIPA, if the setting for the IP address (IPv4) is set to „Obtain automatically“, a connection to the device can be established via this even without a router or fixed IP addresses. It is not recommended to use APIPA in general to establish a connection for device control by chromatography software.

6.6 Controlling the drive via the multi-pin connector

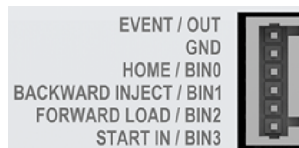

Fig. 7: Multi-pin connector on the rear of the device

On the rear of the valve drive are sockets on a terminal strip. Signals can be sent and received by other devices via those sockets. One can use short-circuit contacts from other devices to send signals to the valve drive. All voltages between GROUND and the corresponding input or output must be connected.

NOTICE

Electronic defect

Connecting cables to the multi-pin connector of a switched on device causes a short circuit.

- Turn off the device before connecting cables.
- Pull the power plug.

NOTICE

Electronic defect

Electrostatic discharge can destroy the electronics.

- Wear a protective bracelet against electrostatic discharge and ground.

- Prerequisites**
- The device has been switched off.
 - The power plug has been pulled.

Tools Operating tool

- Process**
1. Insert the operating tool ③ into an upper small opening on the front of the terminal strip ①.
 2. Lead the cable into the opening ② below the inserted operating tool.
 3. Remove the operating tool.

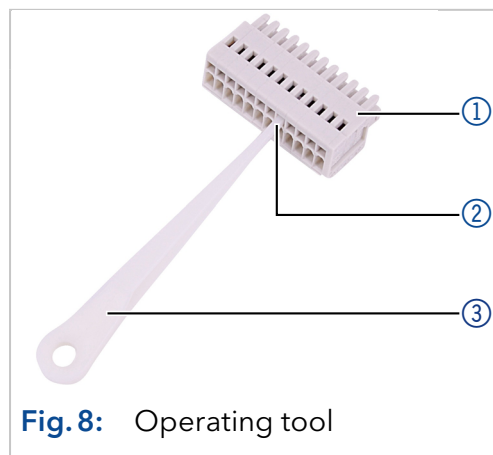

Fig. 8: Operating tool

- Next steps** Check if the cables are firmly attached. Push the terminal strip onto the multi-pin connector. Finish the installation. Put the device into operation.

6.7 Remote control via temporary short circuit (pulse)

Prerequisites The control of the valve drive is set to input (manual control).

The following table describes the effects of the firmware settings on the signal inputs and outputs (see chapter “6.6 Controlling the drive via the multi-pin connector” on page 21).

Signal	Explanation
EVENT/OUT	<p>Output Modes:</p> <p>OC: TTL compatible output</p> <ul style="list-style-type: none"> Passive 5 V (default with external Pull-Up up to 24 V/25 mA) Active 0 V
	<p>TTL: TTL output</p> <ul style="list-style-type: none"> Active 5 V Passive 0 V
	<p>Output Pin:</p> <p>Switch pulse: The output behavior is the same as for “EVENT” mode, adding 1000 ms ACTIVE state pulses produced at every valve position change.</p> <p>Trigger: Set output to ACTIVE state at HOME position for 2 position valves and to INACTIVE state for multi-position valves. In positions other than HOME device sets output to INACTIVE state for 2 position valves and in ACTIVE state for multiposition valve.</p>

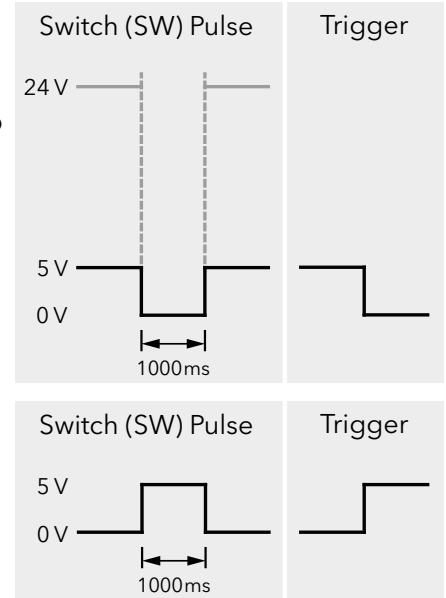

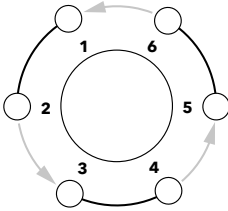
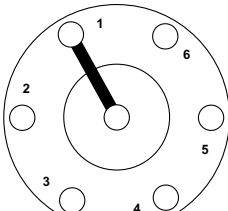
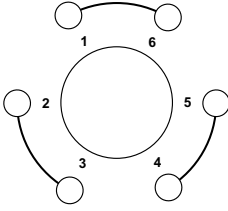
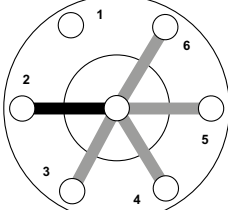
Signal	Explanation
EVENT/OUT (continuation)	<ul style="list-style-type: none"> ■ Trigger signal: <ul style="list-style-type: none"> - 2 position valve to position 2 (Home)  <ul style="list-style-type: none"> - multiposition valve to position 1 (Home)  <ul style="list-style-type: none"> ■ No trigger signal: <ul style="list-style-type: none"> - 2 position valve to position 1  <ul style="list-style-type: none"> - multiposition valve not to position 1 
GND	<p>Reference point of the voltage at the signal inputs</p>
HOME/BIN0	<p>TTL input</p> <ul style="list-style-type: none"> ■ Low active <p>Secure switching threshold min. 10 mA</p> <p>After receiving a signal (short-circuit to GND) from an external device:</p> <ul style="list-style-type: none"> ■ Valve drive is set to position 1.

Event: The output is **controlled either by running device program** or by direct EVENT command sent from controlling software. **Event must be enabled if device should be controlled by software.**

Signal	Explanation
BACKWARD INJECT/BIN1	<p>TTL input</p> <ul style="list-style-type: none"> Low active <p>Secure switching threshold min. 10 mA</p> <p>After receiving a signal (short-circuit to GND) from an external device:</p> <ul style="list-style-type: none"> INJECT (position 2 for 2 position valves) Move to the next lower port of the valve, e. g. from position 6 to position 5
FORWARD LOAD/BIN2	<p>TTL input</p> <ul style="list-style-type: none"> Low active <p>Secure switching threshold min. 10 mA</p> <p>After receiving a signal (short-circuit to GND) from an external device:</p> <ul style="list-style-type: none"> LOAD (position 1 for 2 position valves) Move to the next higher port of the valve, e. g. from position 2 to position 3
START IN/BIN3	<p>TTL input</p> <ul style="list-style-type: none"> Low active <p>Secure switching threshold min. 10 mA</p> <p>Only available when using software: After receiving a signal (short-circuit to GND) from an external device, the device starts a software run.</p>

6.8 Remote control via short-circuit contacts (binary control)

If the valve drive was set to binary operation (see chapter "7.6.4 Input" on page 34), then the connections BIN 0 - BIN 3 are available as control inputs.

6.8.1 Binary code

A binary code is entered during binary control so that the valve can be set externally in the correct position (nominal position).

Prerequisites The valve drive was set to binary control (see chapter "7.6.4 Input" on page 34).

Position	BIN0 ($2^0 = 1$)	BIN1 ($2^1 = 2$)	BIN2 ($2^2 = 4$)	BIN3 ($2^3 = 8$)
1	0	0	0	0
2	1	0	0	0
3	0	1	0	0
4	1	1	0	0
5	0	0	1	0
6	1	0	1	0
7	0	1	1	0
8	1	1	1	0
9	0	0	0	1
10	1	0	0	1
11	0	1	0	1
12	1	1	0	1
13	0	0	1	1
14	1	0	1	1
15	0	1	1	1
16	1	1	1	1

6.9 Ground connection

NOTICE

Electronic defect

Electronic hazard when using an identically constructed power adapter from another manufacturer.

→ Only use spare parts and accessories from KNAUER or a company authorized by KNAUER.

The valve drive has an icon  for the ground connection on the rear of the device.



Note: If the supplied power adapter is used, then the ground connection remains unused.

7. Operation



You have several options to select a particular port with the valve drive:

- With chromatography software
- With the keypad
- With the terminal strip (see chapter "6.5.6 Assigning IP addresses" on page 20)



Note: It is not possible to use 2 control methods simultaneously. Example: If the device is connected to the software, it cannot be controlled via keypad.

7.1 Switch on and self test

Process	Figure
<ol style="list-style-type: none"> 1. Connect the valve drive with the plug from the external power adapter. 2. The start display is shown. 	
<ol style="list-style-type: none"> 3. Wait until the self test has been completed. 4. Once an error message appears in the display, it can be deleted by pressing any button. 5. The main display is shown. 	

The error messages after self test show an error (see chapter "9. Troubleshooting" on page 38) or if the rotor seal has to be replaced.

7.2 Operating with chromatography software



To operate the device with software, you have to establish a connection between the LAN port and a computer. The valve drive can be operated with one of the available chromatography data systems (OpenLAB® EZ-Chrom Edition, ClarityChrom®, Chromeleon™, PurityChrom® and Mobile Control Chrom). You find a detailed description on chromatography software in a corresponding user manual.

7.3 Operating with the keypad

The keypad consists of 4 buttons, which allow to operate the device.



Note: If no buttons are pressed within 10 seconds, the display returns to the main display.

Figure	Name	Function
	Navigation buttons	<ul style="list-style-type: none"> ■ Scrolling through menu ■ Changing values
	Selection button	<ul style="list-style-type: none"> ■ Select menu ■ Select value to change ■ Return to main display by pressing for 3 seconds
	Confirmation button	Confirm selection

7.3.1 Navigate through menu

1. Press selection button. The first main menu point appears.
2. Scroll through the main menu using the navigation buttons.
3. Click main menu point with selection button to enter the submenu.

7.3.2 Changing values

1. Navigate in the menu to a value that has to be changed.
2. A cursor is situated in the value. Move the cursor with the navigation buttons to the relevant spot.
3. Press selection button. The value can now be changed.
4. Using the navigation buttons, set the value.
5. Using the confirmation buttons, confirm the value.

7.4 Menu guide

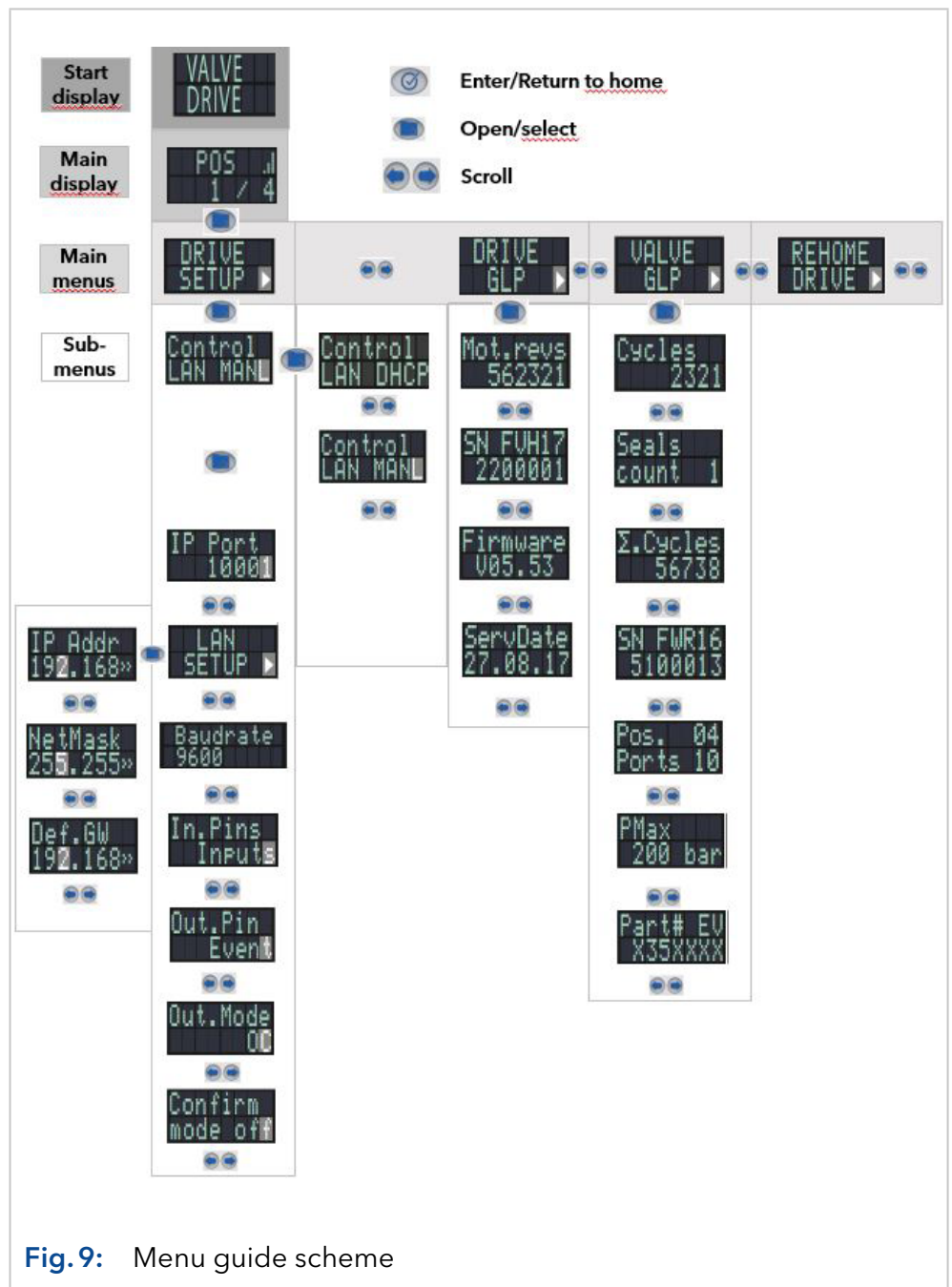

7.4.1 Start display

After switching on the device, the start display appears. After a short time, the view changes to the main display.

Menu	Explanation	Figure
Start display	Shows device name.	

7.4.2 Main display



The main display is the default view of the device. You can return from any point of the menu to this display by using one of these options:

- Wait for 5 seconds.
- Press the confirmation button.
- Press the selection button for 5 seconds.

Menu	Explanation	Figure
Main display	Shows the RFID status (icon in upper right corner), the current valve position (left number) and the total number of valve positions (right number).	

7.4.3 Main menu

Press the selection button to enter the main menu from the main display. Scroll through the main menu using the navigation buttons. Confirm with selection button to enter the submenu.

Menu	Explanation	Figure
Drive Setup	Set the valve drive.	
Drive GLP	Retrieve GLP data of the valve drive.	
Valve GLP	Retrieve GLP data of the valve.	







Menu	Explanation	Figure
Rehome Drive	Reset the position of the valve drive to Home position.	

7.4.4 Submenus

Press the selection button to enter the submenu from the main menu. Scroll through the menu using the navigation buttons. Change the settings using the selection button.





Drive Setup

Set the valve drive.

Menu	Explanation	Figure
Control	Set the LAN settings to manual or DHCP.	
IP Port	Set the IP port	
LAN Setup	Set the IP address, subnet mask or gateway	
In.Pins	Set if the input control is set manually or binary	
Out.Pin	Set if the output control is set via event or via trigger	
Out.Mode	Set if the output control is set via OC or via TTL	
Confirm mode	Set if changes of the valve position are applied immediately (OFF) or after confirmation (ON)	





Drive GLP

Retrieve GLP data of the valve drive.

Menu	Explanation	Figure
Mot.revs.	Number of switching cycles of the valve drive	
Serial Number	Serial number of the valve drive	
Firmware	Version of the firmware	
Service Date	Last service date	

Valve GLP

Retrieve GLP data of the valve.

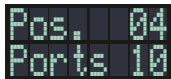
Menu	Explanation	Figure
Switching Cycles	Number of switching cycles of the mounted valve with current rotor seal	
Seals Count	Number of replaced rotor seals	
Total Cycles	Selection of the total switching cycles of the mounted valves	
Serial Number	Serial number of the mounted valve	
Valve Information	Number of positions and ports of the mounted valve	

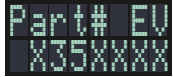
Menu	Explanation	Figure
Maximum Pressure	Information of the maximum pressure of the mounted valves	
Part Number	Part number of the mounted valve	



7.5 Setting the valve position

Depending of the setting in Confirmation Mode, the valve position can be set immediately (OFF) or after confirmation (ON).

7.5.1 Setting the valve position immediately

Process	Figure
<ol style="list-style-type: none"> In main display, set the position via the navigation buttons. Release the navigation button. The position is set immediately. 	

7.5.2 Setting the valve position after confirmation

Process	Figure
<ol style="list-style-type: none"> Change to Confirmation Mode: Main Display > DRIVE SETUP > Confirmation Mode Press selection button. Use the navigation buttons to set the setting from OFF to ON. Finish the process by pressing the confirmation button. 	
<ol style="list-style-type: none"> Change to main display. Use the navigation buttons to set a value for the position. Confirm the selection by pressing the confirmation button. 	

7.6 Setting the valve drive control

7.6.1 LAN control

In this submenu is set whether the LAN control is set to manual or via DHCP.

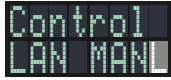
Process	Figure
<ol style="list-style-type: none"> 1. Change to control display: Main Display > DRIVE SETUP > Control 2. Press selection button. 3. Change the setting (DHCP/MANL) via the navigation buttons. 4. Finish the process by pressing the confirmation button. 	

7.6.2 IP Port



In this submenu, the IP port can be set manually.

Process	Figure
<ol style="list-style-type: none"> 1. Change to IP port display: Main Display > DRIVE SETUP > IP Port 2. Press selection button. 3. Using the navigation buttons, navigate to the value that has to be changed. 4. Press selection button. 5. Using the navigation buttons, set the digit. 6. Finish the process by pressing the confirmation button. 	

7.6.3 LAN settings

In this submenu, the IP address, netmask and gateway can be set manually.

Process	Figure
<ol style="list-style-type: none"> 1. Change to LAN Setup display: Main Display > DRIVE SETUP > Control LAN MANL / Control LAN DHCP > LAN SETUP 2. Press selection button. 3. Using the navigation buttons, navigate to the value that has to be changed. 4. Press selection button. 	

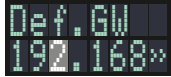
Process	Figure
<p>IP address</p> <ol style="list-style-type: none"> 1. In the LAN SETUP display, select the submenu IP Addr with the navigation buttons. 2. Press selection button. 3. Using the navigation buttons, navigate to the value that has to be changed. 4. Finish the process by pressing the confirmation button. 	
<p>Netmask</p> <ol style="list-style-type: none"> 1. In the LAN SETUP display, select the submenu NetMask with the navigation buttons. 2. Press selection button. 3. Using the navigation buttons, navigate to the value that has to be changed. 4. Finish the process by pressing the confirmation button. 	
<p>Gateway</p> <ol style="list-style-type: none"> 1. In the LAN SETUP display, select the submenu Def with the navigation buttons. Choose GW. 2. Press selection button. 3. Using the navigation buttons, navigate to the value that has to be changed. 4. Finish the process by pressing the confirmation button. 	

7.6.4 Input

In this submenu, the control can be switched from manual to binary (see chapter "6.8.1 Binary code" on page 24).

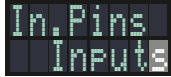

Process	Figure
<ol style="list-style-type: none"> 1. Change to Input display: Main Display > DRIVE SETUP > In.Pins 2. Press selection button. 3. Change the setting (Inputs/BinCode) via the navigation buttons. 4. Finish the process by pressing the confirmation button. 	

7.6.5 Output

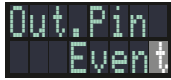
In this submenu, the output control can be set to event or to trigger.

Process	Figure
<ol style="list-style-type: none"> 1. Change to Output display: Main Display > DRIVE SETUP > Out.Pin 2. Press selection button. 3. Change the setting (Event/Trigger) via the navigation buttons. 4. Finish the process by pressing the confirmation button. 	

7.7 Setting to standby

Process	Figure
<ol style="list-style-type: none"> 1. Keep the selection button pressed for about 3 seconds. 2. STANDBY is shown on the display and the status LED on the device lights blue. 	
<ol style="list-style-type: none"> 3. To change to normal operation again, keep the selection button pressed for 3 seconds. 4. The main menu is shown on the display and the status LED on the device lights green. 	

7.8 Setting valve position to Home

In this submenu, the valve position can be set to Home.

Process	Figure
<ol style="list-style-type: none"> 1. Change to main menu point REHOME DRIVE. 2. Press selection button. 	

7.9 Replacing rotor seal

After a defined number of switching cycles, the valve drive reports that the rotor seal has to be replaced.

Prerequisite The rotor seal has been replaced.



Note: You find information about the rotor seal replacement in the document V6864: www.knauer.net/v6864_en

Process	Figure
<ol style="list-style-type: none"> After the start display, the message <REPLACE SEAL!> is shown. This message is dismissed by pressing any button. 	
<ol style="list-style-type: none"> The screen changes to the main display. The warning sign in the upper right corner shows that the rotor seal has to be replaced. 	
<ol style="list-style-type: none"> Change to Seals Count screen: Main Display > Valve GLP > Seals count Press the selection button for 3 seconds. 	
<ol style="list-style-type: none"> The message <Set new seal?> appears. Press confirmation button. The screen changes to Seals Count display. To cancel the process, push another random button. The screen changes to the Total Cycles display. 	

8. Functionality tests



Note: Standard processes regarding IQ and OQ in single devices may be handled differently in individual cases.

8.1 Installation Qualification (IQ)

The customer may request the Installation Qualification, which is free of charge. In case of a request, the technical support of KNAUER or a provider authorized by KNAUER performs this functionality test during the installation.

The Installation Qualification is a standardized document that includes the following:

- confirmation of flawless condition at delivery
- check if the delivery is complete
- certification on the functionality of the device

You can either use the IQ document attached to this instruction manual or download a digital version from our website:



8.2 Operation Qualification (OQ)

The Operation Qualification includes an extensive functionality test according to KNAUER standard OQ documents. The Operation Qualification is a standardized document and free of charge. It is not part of the delivery. Please contact the technical support in case of a request.

The Operation Qualification includes the following:

- definition of customer requirements and acceptance terms
- documentation on device specifications
- device functionality check at installation site

Test intervals To make sure that the device operates within the specified range, you should test the device regularly. The test intervals depend on the usage of the device.

Execution The test can be carried out either by the technical support of KNAUER or by a provider authorized by KNAUER (for a fee). For further information visit our website:





9. Troubleshooting

9.1 LAN

Follow the steps below, in case no connection between the computer and the devices can be established. Check after each step if the problem is solved. If the problem cannot be located, call the Technical Support.

1. Check the status of the LAN connection in the Windows task bar:

-  Connected
-  Connection not established

If no connection has been established, check the following:

- Is the router switched on?
 - Is the patch cable connected correctly to the router and the computer?
2. Check the router settings:
- Is the router set to DHCP server?
 - Is the IP address range sufficient for all the connected devices?
3. Check all connections:
- Are the patch cable connected to the LAN ports and not the WAN port?
 - Are all cable connections between devices and router correct?
 - Are the cables plugged in tightly?
4. If the router is integrated into a company network, pull out the patch cable from the WAN port.
- Can the devices communicate with the computer, even though the router is disconnected from the company network?
5. Turn off all devices, router, and computer. Firstly, switch on the router and wait until its self-test is finished. Secondly, switch on the devices and the computer.
- Has this been successful?
6. Replace the patch cable to the device with which no connection could be established.
- Has this been successful?
7. Make sure that the IP port of the device matches the port in the chromatography software.

9.2 Error messages

The display shows the error message. In addition, the status LED blinks red (see chapter "1.4 Status display" on page 3). If the red LED does not blink, the error is fatal. Contact the Technical Support.

Depending on the display installed, the error messages are displayed differently. One display type shows a static error message, the other display type shows the corresponding error message as a ticker.

Display	Display - dynamic	Cause of the error	Solution
ERROR:446	ERROR:446,RFID tag reading failure	RFID tag could not be read.	Valve is worn out. Replace the valve.
ERROR:447	ERROR:447,RFID tag writing failure	RFID tag could not be written.	Valve is worn out. Replace the valve.
ERROR:30005	ERROR:30005,Valve was hot swapped. Rehoming needed	Valve has been replaced during ongoing operation.	Restart the device.
ERROR:30006	ERROR:30006,Valve RFID tag was not found	Valve was not recognized.	Remount the device.



Note: If it is not possible to solve the error or if a new error appears, restart the device. If the error reappears, contact the Technical Support.

10. Maintenance and care

10.1 Cleaning the device

NOTICE

Device defect

Intruding liquids can cause damage to the device.

- Place solvent bottles next to the device or in a solvent tray.
 - Moisten the cleaning cloth only slightly.
-

All smooth surfaces of the device can be cleaned with a mild, commercially available cleaning solution, or with isopropanol.

10.2 Transport

Carefully prepare the device for transport. If you want to return your device to KNAUER for repairs, enclose the Service Request Form which can be downloaded from our website.

For a secure transport, note the weight and dimensions of the device (see chapter "11. Technical data" on page 41).

⚠ CAUTION

Bruising danger

Damage to the device by carrying or lifting it on protruding housing parts. The device may fall and thus cause injuries.

- Lift the device only centrally on the side of the housing.
-

11. Technical data

Permitted operating environment	Area of use	For indoor use only
	Line voltage fluctuations do not exceed $\pm 10\%$ of normal voltage.	
	Oversoltage category II:	Energy consumers are supplied by a fixed device.
	Permitted pollution degree	2
	Temperature range	4-40 °C (39.2-104 °F)
	Air humidity	below 90 %, non-condensing
	Operating height	max. 2 000 Meters above sea level
Valve drive (without valve)	Control	LAN, RS-232, keypad
	Dimensions (W x H x D)	80 x 123 x 153 mm (without adapter) 80 x 123 x 192 mm (with adapter)
	Weight	2 kg
	Display	LCD
	Power supply	Power adapter 24 V DC, 65 W

12. Repeat orders

12.1 Valve drive and accessories

Name	Order no.
Valve drive AZURA® Valve Unifier VU 4.1	AWA01XA
Accessory kit AZURA® Valve Unifier VU 4.1	FWA01

12.2 Power cable

Name	Order no.
Power cable for Germany	M1642
Power cable for UK	M1278
Power cable for USA	M1651
Power adapter	G1677A

13. Disposal

Hand in old devices or disassembled old components at a certified waste facility, where they will be disposed of properly.

13.1 AVV-Marking Germany

According to the German "Abfallverzeichnisverordnung" (AVV) (January, 2001), old devices manufactured by KNAUER are marked as waste electrical and electronic equipment: 160214.



13.2 WEEE registration number

KNAUER as a company is registered by the WEEE number DE 34642789 in the German "Elektroaltgeräteregister" (EAR). The number classifies to category 8 and 9, which, among others, comprises laboratory equipment.

All distributors and importers are responsible for the disposal of old devices, as defined by the WEEE directive . End-users can send their old devices manufactured by KNAUER back to the distributor, the importer, or the company free of charge, but would be charged for the disposal.

Appendix: Installation Qualification (IQ)

Installation Qualification (IQ) for a Device

	Created	Reviewed	Approved
Function	Technical editor	Engineering	Head of Quality
Name	Anna Erben	Paul Pietsch	Kate Monks
Date	23/08/2022	29/08/2022	30/08/2022
Signature	 <small>Digital unterschrieben von Anna Erben Datum: 2022.08.23 14:09:27 +02'00'</small>		

0. Customer approval

Prior to installation at the customer site, the customer has reviewed the OQ document and agrees with the design and scope

Company name:

Name	Function	Reviewed & approved	Date	Signature

Installation Qualification (IQ) for a Device

1. Definition of the Installation Qualification

The qualification document „Installation Qualification (IQ)“ is part of the quality management system at the company KNAUER Wissenschaftliche Geräte GmbH.

2. Scope

The customer can request the Installation Qualification. In case of a request, the technical support of KNAUER or a provider authorized by KNAUER performs this functionality test during the installation. The IQ is a standardized document and includes the following:

- Confirmation of flawless condition at delivery
- Check if the delivery is complete
- Certification on the functionality of the device

3. Instructions

All deviations from the specifications that occurred during installation have to be recorded in this document.

In addition, all measures taken to eliminate the deviations have to be noted down as comments in the list of rectifications (LOR) on page 4.

If certain items in the report are not applicable, this has to be indicated in the table as „N/A“ (not applicable). Major sections that are not used have to be crossed out (diagonal line), marked „N/A“, dated and signed.

All required documents have to be completed by the end of the installation. The document has to be reviewed and approved by an authorized person. The review and approval have to be documented with signature and date (DD/MM/YYYY).

The tests have to be carried out in a suitable environment, as described in the user instruction of the device.

4. About this document

The information in this document is subject to change without prior notice. This document may not be used, reproduced or translated without written consent of KNAUER Wissenschaftliche Geräte GmbH. Depending on the customer's quality assurance system, the signed document either has to be filed in the device folder or scanned and stored in an electronic archive.

5. Device data

Device name		Product number	
Serial number		Order number	
Firmware version			
Installation location			

6. Customer and manufacturer data

	Customer	Manufacturer
Company		KNAUER Wissenschaftliche Geräte GmbH
Customer number		-
Contact person/agent		
Address		Hegauer Weg 38
Postal Code/City		14163 Berlin
Phone		+49 30 80 97 27 111
E-Mail		support@knauer.net

Installation Qualification (IQ) for a Device

7. Installation Qualification Tests

Test	Description	Specification	Passed	Failed	N/A	Comment/LOR No.
1	Identify the device.	The name on the device matches the name on the delivery order.				
2	Check the device for transport damage.	No transport damage is observed.				
3	Check the scope of delivery.	The scope of delivery matches the packing list and/or the delivery order.				
4	Check that the technical documentation provided is correct and complete (material documentation of wetted parts, calibration certificates etc.)	The documentation is correct and complete.				
5	Check that all equipment is properly and correctly labeled according to the delivery order and/or the labeling specifications document, if applicable.	The equipment is labeled correctly.				
6	Connect all loose parts (e.g. capillaries, tubings, measuring head) according to the user instructions.	The device is fully assembled and ready to use.				
7	Ensure that the installation site is suitable according to the user instructions.	The installation site matches the specifications in the user instructions.				
8	Connect the device to the power supply and switch it on.	The device starts (operating noise). The power LED or the display lights up.				

Installation Qualification (IQ) for a Device

9. List of changes to the document

Revision no.	Description of change	Additional information	Date/signature

Installation Qualification (IQ) for a Device

10. Certificate and approval

A KNAUER employee or an employee authorized by KNAUER has checked the device and performed all tests described in the IQ.

The IQ form has to be signed by an authorized person. The scope of the IQ meets the customer's requirements.

The results of the IQ, any changes made as well as the IQ process have been documented in this form in writing. The users listed below were instructed and are familiar with how to operate the device. Both parties confirm that the IQ has been performed to the customer's satisfaction by signing it.

10.1 Customer approval

Name	Function	Date	Signature

10.2 KNAUER agent approval

Name	Function	Date	Signature

11. Comments / recommendations

Science with Passion



Latest KNAUER instructions online:
www.knauer.net/library

KNAUER
Wissenschaftliche Geräte GmbH
Hegauer Weg 37-38
14163 Berlin

Phone: +49 30 809727-0
Fax: +49 30 8015010
E-mail: info@knauer.net
Internet: www.knauer.net