



ANTEC DECADE ELITE

Clarity Control Module

ENG

Code/Rev.: M179/80B
Date: 3/27/2019

Phone: +420 251 013 400
Fax: +420 251 013 401
clarity@dataapex.com
www.dataapex.com

DataApex Ltd.
Petrzilkova 2583/13
158 00 Prague 5
The Czech Republic

Clarity[®], DataApex[®] and ▲[®] are trademarks of DataApex Ltd. Microsoft[®] and Windows[™] are trademarks of Microsoft Corporation.

DataApex reserves the right to make changes to manuals without prior notice. Updated manuals can be downloaded from www.dataapex.com.

Author: MP

Contents

1 Antec DECADE Elite Control Module	1
2 Requirements	2
3 Installation Procedure	3
3.1 Hardware - Wiring	3
3.2 DECADE Elite digital inputs and outputs	4
3.3 Clarity Configuration	7
4 Using the control module	10
4.1 Method Setup - Acquisition	10
4.1.1 Method Setup - Acquisition - Main	11
4.1.2 Method Setup - Acquisition - Output	13
4.1.3 Method Setup - Acquisition - Time Table	15
4.2 Method Setup - Event Table	16
4.3 Method Setup - Advanced	17
4.4 Device Monitor	18
4.5 Antec Detector Setup	20
4.6 Digital Outputs Control	25
5 Report Setup	26
6 Troubleshooting	27
6.1 others.ini File Setup	27

To facilitate the orientation in the **Antec DECADE Elite** manual and **Clarity** chromatography station, different fonts are used throughout the manual. Meanings of these fonts are:

Instrument (blue text) marks the name of the window to which the text refers.

Open File (italics) describes the commands and names of fields in **Clarity**, parameters that can be entered into them or a window or dialog name (when you already are in the topic describing the window).

WORK1 (capitals) indicates the name of the file and/or directory.

ACTIVE (capital italics) marks the state of the station or its part.

The bold text is sometimes also used for important parts of the text and the name of the **Clarity** station. Moreover, some sections are written in format other than normal text. These sections are formatted as follows:

Note: Notifies the reader of relevant information.

Caution: Warns the user of possibly dangerous or very important information.

Marks the problem statement or trouble question.

Description: Presents more detailed information on the problem, describes its causes, etc.

Solution: Marks the response to the question, presents a procedure how to remove it.

1 Antec DECADE Elite Control Module

This manual describes the setting of the **Antec DECADE Elite** and **DECADE Lite** Electrochemical detectors. The control module enables direct control of the instrument over USB or LAN, depending on the communication interface installed in the detector.



Fig 1: Antec DECADE Elite detector

Direct control means that the detector can be completely controlled from the **Clarity** environment. Instrument method controlling the analysis conditions will be saved in the measured chromatograms.

2 Requirements

- **Clarity** Installation CD ROM with LC Control module (p/n A24).
- Free USB port in the PC or detector connected to the same LAN as the PC.
- LAN cable (p/n SK08) for network-connected detector or USB A-B cable (p/n SK06) for USB-connected one.

Note: Cables are not part of **Clarity** Control Module. It is strongly recommended to order required cables together with the Control Module.

3 Installation Procedure

3.1 Hardware - Wiring

The **Antec DECADE Elite** detector is controlled either by serial (RS232) or LAN communication. For the RS232 communication, there is an embedded USB-to-RS232 port, which requires standard A-B USB cable (p/n SK06) to use. For the LAN communication, standard cross LAN cable (p/n SK08) is used.

3.2 DECADE Elite digital inputs and outputs

The **Antec DECADE Elite** detector is, besides the USB or LAN connector, equipped with several other connectors allowing the use of various digital inputs and digital outputs. The connectors are placed on the back panel of the instrument and shown in the picture below:

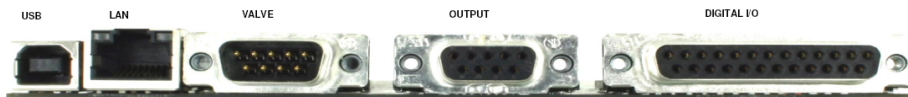

Fig 2: Back panel of the Antec DECADE Elite detector

There are three input/output connectors installed on the back side of the **Antec DECADE Elite** that are not used for the digital communication. **Valve** is 9-pin DB9M connector, **Output** is a 9-pin DB9F connector and **Digital I/O** is 25-pin DB25F connector. **Valve** connector is used for operating the optionally connected inject valve, **Output** connector hosts analog signal outputs and **Digital I/O** contains pins used for digital inputs and digital outputs of the **Antec DECADE Elite** detector. Both **Valve** and **Output** connectors have the same orientation and organization of pins, but individual pins serve for different purposes.

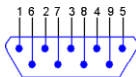

Fig 3: Valve (DB9M) and Output (DB9F) connector

The meanings of individual pins are as follows:

Tab 1: Valve connector contacts

Pin No.	Pin Name
1, 5	GND
2	Transmit (TxD)
3	Receive (RxD)
4	-
6	Switch (Handvalve)
7	-
8	-
9	Inject Marker

Tab 2: Output connector contacts

Pin No.	Pin Name
1	Analog Output 1
2	Analog Output 2
3	Analog Output 3
4	Analog Output 4
5	Analog Output 5
6-9	GND

The Digital I/O connector has different pin allocation:

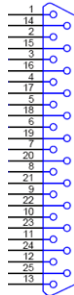

Fig 4: Digital I/O (DB25F) connector

Tab 3: Digital I/O connector contacts

Pin No.	Type	Function in Default setting
1	Relay Output	Relay 1 - NC
2	Relay Output	Relay 1 - NO
3	Relay Output	Relay 1 - Common
4	Relay Output	Relay 2 - NC
5	Relay Output	Relay 2 - NO
6	Relay Output	Relay 2 - Common
7	TTL Output	AUX 1
8	TTL Output	AUX 1
9	TTL Output	AUX 1
10	TTL Output	AUX 1
11	TTL Output	Overload
12	TTL Input	Cell 1 On
13	TTL Input	Cell 2 On
14	TTL Input	Cell 3 On
15	TTL Input	Cell 1 Off
16	TTL Input	Cell 2 Off

Pin No.	Type	Function in Default setting
17	TTL Input	Cell 3 Off
18	TTL Input	Cell 1 Autozero
19	TTL Input	Cell 2 Autozero
20	TTL Input	Cell 3 Autozero
21	TTL Input	Cell 1 Start IN
22	TTL Input	Cell 2 Start IN
23	TTL Input	Cell 3 Start IN
24	TTL Input	Cell 4 Start IN
25	GND	GND

Note: Level triggered TTL input contacts require a minimum TTL *LOW* pulse duration of 100 ms. If multiple activations are required, the next pulse should be given after at least 100 ms TTL *HIGH*. When the input is kept *LOW*, only one activation will occur. The default value for the TTL output is *HIGH* (5 V).

The use of digital inputs and outputs in **Clarity** is described in the topic concerning [Antec Detector Setup](#) dialog (for more details see also chapter **Antec Detector Setup** on pg 20).

Caution: **Clarity** expects that the Inputs and Outputs are set in the default state. Do not change the mapping of inputs and outputs if you want to use them in **Clarity**.

3.3 Clarity Configuration

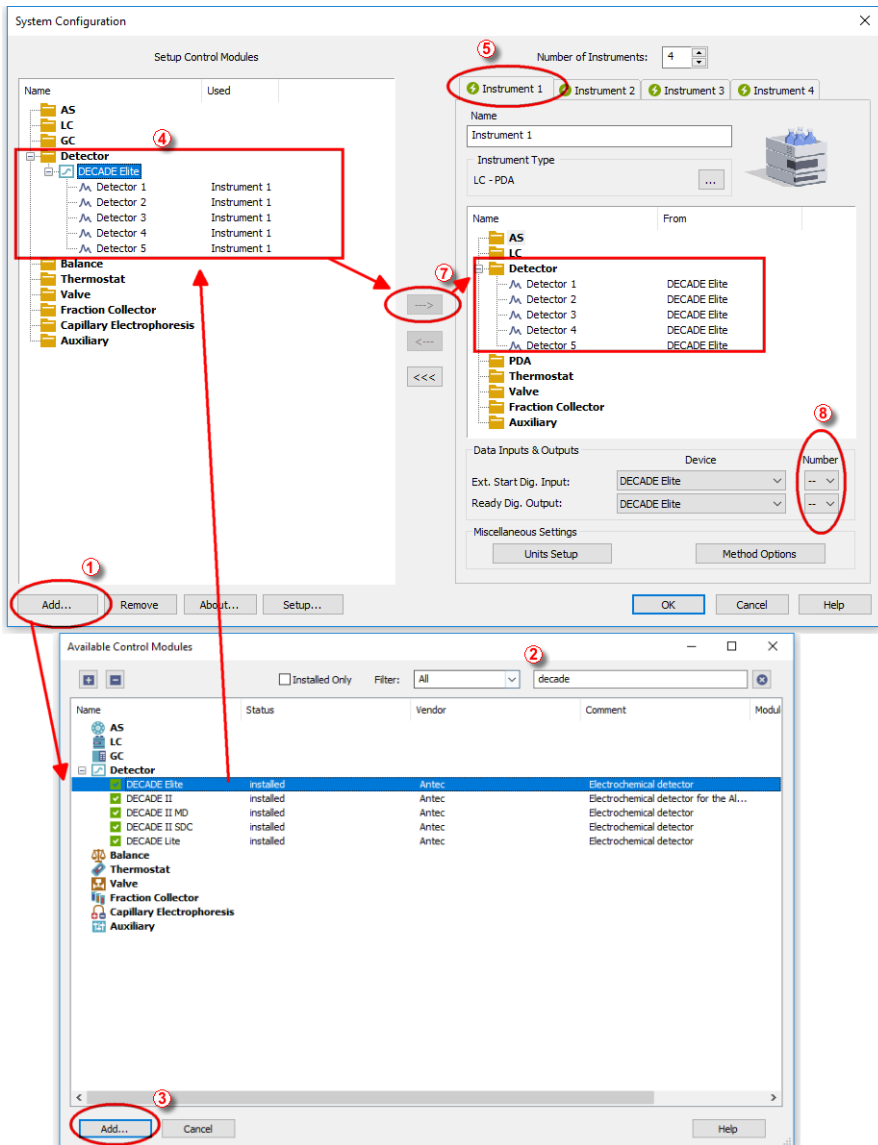



Fig 5: System Configuration



- Start the **Clarity** station by clicking on the  icon on the desktop.
- Invoke the **System Configuration** dialog accessible from the **Clarity** window using the *System - Configuration...* command.
- Press the *Add* button ① (see 3.3 on pg 7.) to invoke the **Available Control Modules** dialog.
- You can specify the searching filter ② to simplify the finding of the driver.
- Select the **Antec DECADE Elite** detector and press the *Add* ③ button.

The **Antec Detector Setup** dialog will appear.

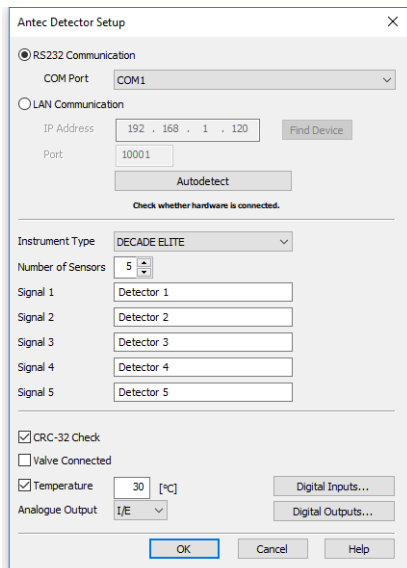



Fig 6: Antec Detector Setup

- Select the correct type of the *Communication* and fill in the appropriate *COM Port* or *IP Address*, then press the *Autodetect* button. You can also choose your detector from the list after pressing *Find Device* button. If the communication is correct, model type including the number of configured cells will appear below the *Autodetect* button. Press the *OK* button to close the **Antec Detector Setup** dialog.

Note: The **Antec Detector Setup** dialog is more closely described in the chapter "**Antec Detector Setup**" on pg 20.

The **Antec DECADE Elite** item will appear in the *Setup Control Modules* list of the **System Configuration** dialog.

- Drag and drop the **Antec DECADE Elite** icon from the *Setup Control Modules* ④ list on the left side of the **System Configuration** dialog to the desired *Instrument* ⑤ tab on the right side ⑥ (or use the  button ⑦ to do so).
- Set the *Ext. Start Dig. Input* and *Ready Dig. Output* numbers ⑧ for your acquisition card according to the wires being used for synchronization.

4 Using the control module

New **Acquisition** tabs (one for each detector signal assigned to the Instrument) are created in the **Method Setup** dialog. They can be accessed by switching to the desired signal in the *Select Detector* section on the top of the dialog.

Note: Detector does not support the *Start - Restart* option in the *External Start Options* section which can be found in the lower right part of the **Method Setup - Measurement** tab.

4.1 Method Setup - Acquisition

The **Method Setup - Acquisition** tab for each signal of the **Antec DECADE Elite** detector has three sub-tabs: **Main**, where basic information on the signal is set, **Output** sub-tab with other signal properties and the **Time Table** sub-tab containing the *Time table* governing the time program of the detector.

In the right section on all **Method Setup - Acquisition** sub-tabs for **Antec DECADE Elite** detectors two buttons are placed:

From Det

Pressing the button loads all detector parameters as they are set in the **Antec DECADE Elite** detector. These parameters are set in appropriate fields of the **Method Setup - Acquisition** dialog.

Det Status

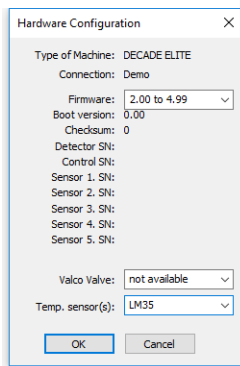

Fig 7: Hardware Configuration

After pressing the *Det Status* button the **Hardware Configuration** dialog opens. It displays the detector type, communication port through which it is connected, used firmware version, serial numbers of all sensor boards that are installed and other information.

4.1.1 Method Setup - Acquisition - Main

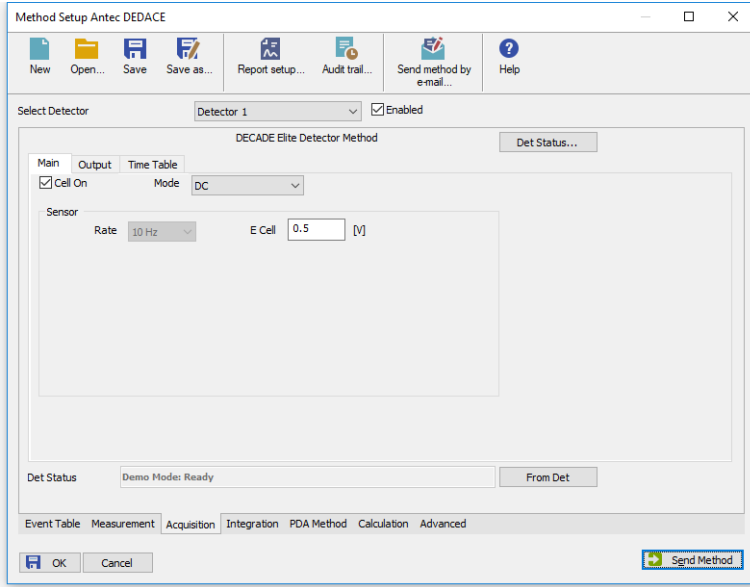

Fig 8: Method Setup - Acquisition - Main

The **Main** sub-tab of the **Method Setup - Acquisition** dialog is used to specify the operation mode of the particular detector and its other parameters.

Cell On

This checkbox enables to switch the particular cell off. The cell is on by default. The analysis cannot be performed while the cell is off, to be able to start it is necessary to disable the particular detector in the top part of its **Method Setup - Acquisition** tab.

Mode

The **Antec DECADE Elite** detector can work in two operation modes - *DC* and *Pulse*. The selection of the mode influences the parameters which can be set in the *Sensor* section.

Sensor

This section differs for the *DC* mode and the *Pulse* mode. In both modes it is used for specifying the sampling *Rate*, the pulse mode uses it for specifying the profile of the pulses in addition.

Rate

Defines the sampling rate of the detector. Possible values range between *1* and *100* Hz. In case of the *Pulse* mode, the Rate is derived

from the length of the pulse - the actual sample rate is shown after the selection field.

E Cell

Defines the potential set on the measurement cell. This parameter is usable only in the *DC* mode.

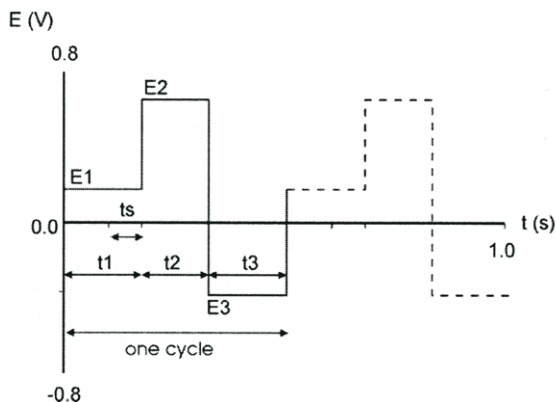

Fig 9: Pulse mode

E1

Defines the measurement potential. This parameter is usable only in the *Pulse* mode.

t1

Sets the time for which the measurement potential will be maintained. This parameter is usable only in the *Pulse* mode.

E2 .. E5

Sets the potential value for the $t2$.. $t5$ time intervals. These parameters are usable only in the *Pulse* mode.

t2 .. t5

Defines the duration of the interval for which the $E2$.. $E5$ potentials will be set. These parameters are usable only in the *Pulse* mode.

Note: The potential set during the $t2$, $t3$, $t4$ and $t5$ time intervals is used to renew the surface of the electrodes.

ts

Sets the sampling time. The time difference between $t1$ and ts values is used to establish the correct value of $E1$. This parameter is usable only in the *Pulse* mode.

4.1.2 Method Setup - Acquisition - Output

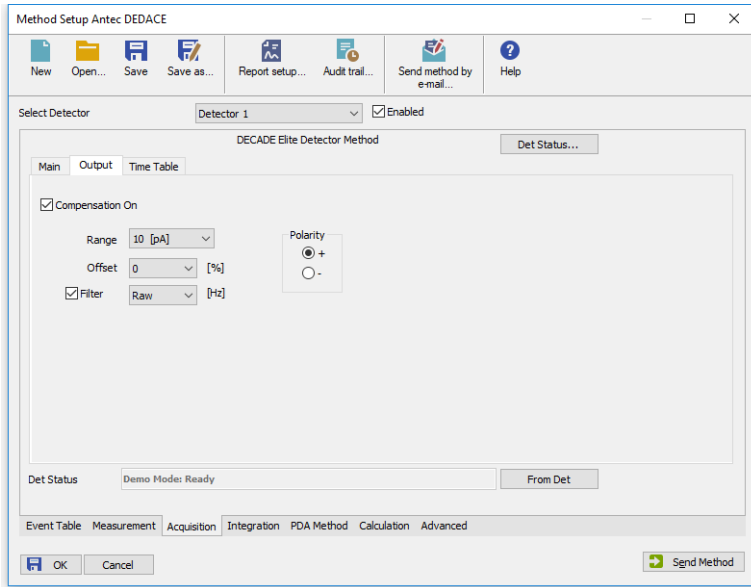

Fig 10: Method Setup - Acquisition - Output

This sub-tab contains other signal parameters of the particular detector. These are:

Compensation On

This checkbox releases or applies an Autozero offset. When unchecked, any applied autozero offset will be released and the uncompensated cell current will be applied to the output.

Range

Sets the range of the detector. The range can be also changed later as a part of the time program of the detector on the [Method Setup - Acquisition - Time Table](#) sub-tab.

Offset

Sets the y-axis offset of the given signal. This offset is set in percentage of the signal range.

Filter

The Filter checkbox allows to use the noise filter for the particular signal. The connected box serves for specifying the cut-off frequency of the filter (possible values range between 0.001 and 10 Hz for the *DC* mode and 0.001 and 0.5 Hz for the *Pulse* mode). For direct setting of sample rate on the [Method Setup - Acquisition - Main](#) tab it is required to set the *Filter* to *Raw*.

Polarity

Sets the polarity of the signal. This parameter may be used for simple switching of negative peaks to positive values.

4.1.3 Method Setup - Acquisition - Time Table

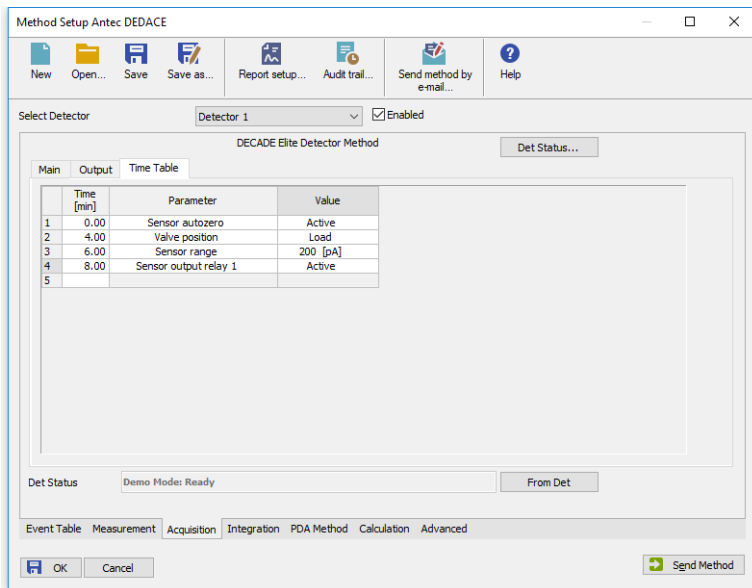

Fig 11: Method Setup - Acquisition - Time Table

The Time table allows to set timed events on the given detector. The following parameters and outputs can be programmed in the time table: *Valve position*, *Sensor range*, *Sensor autozero*, *Sensor offset*, *Sensor E cell*, *Sensor output aux 1(2)*, *Sensor output relay 1(2)*.

Some events set in the Time table will alter the original values possibly set on the [Method Setup - Acquisition - Main](#) or [Method Setup - Acquisition - Output](#) sub-tabs, others govern the digital outputs of given detector or controller board set in the [Antec Detector Setup](#) dialog.

After entering the desired *Time* for the event (in minutes), it is possible to fill in the *Parameter* field with any possibility from the drop-down list. Add the desired value of the parameter in the *Value* column (if applicable).

4.2 Method Setup - Event Table

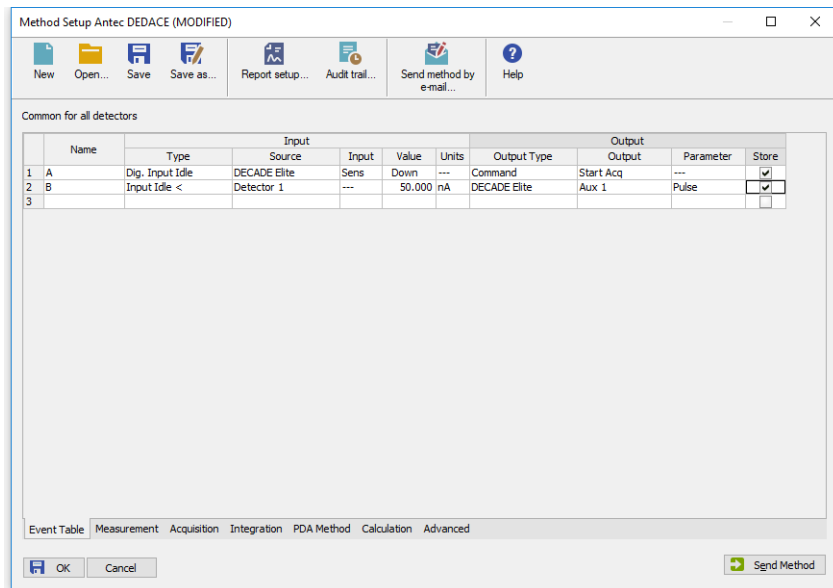

Fig 12: Method Setup - Event Table

Both the inputs and outputs of the **Antec DECADE Elite** detector can be used in the **Event Table**, either as the input conditions or for the output reaction.

4.3 Method Setup - Advanced

The **Antec DECADE Elite** detector also provides auxiliary signals, which can be added to the resulting chromatograms in the **Method Setup - Advanced** dialog.

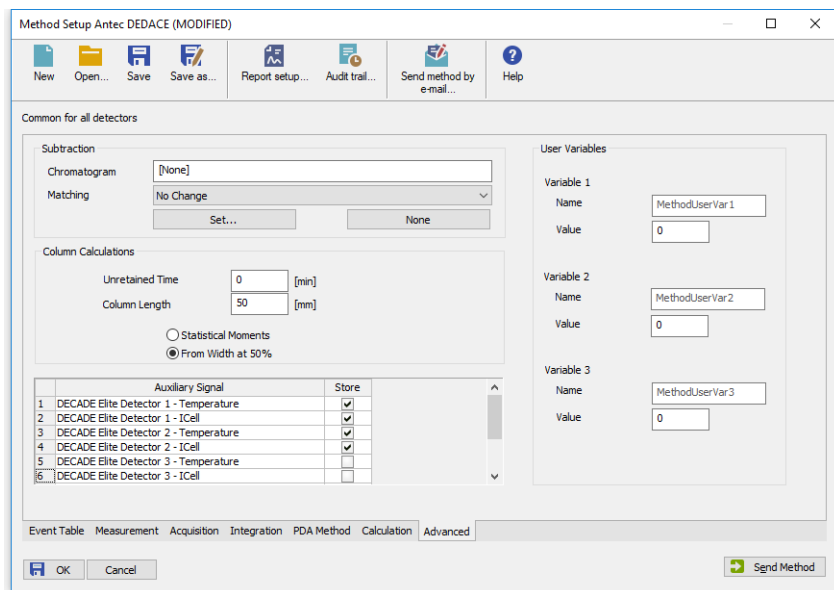



Fig 13: Method Setup - Advanced

Check the checkbox in the *Store* column to save the particular auxiliary signal to the chromatogram.

4.4 Device Monitor

The window with the detector status can be invoked by the *Monitor - Device Monitor* command from the *Instrument* window or using the  *LC Monitor* icon. It displays the actual signal belonging to all signals configured on the Instrument, as well as other information such as the detector temperatures. Each detector has its own section in the *Device Monitor* window.

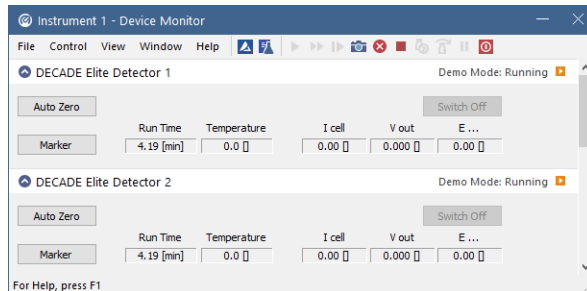

Fig 14: Device Monitor

The detector can be monitored and partially controlled from the *Device Monitor* window. Available control commands and fields are:

Auto Zero

This button performs the autozero operation - the output signal of the detector is set to zero.

Switch Off/Switch On

This button switches the cell *OFF* or *ON*, depending on the previous status of the cell.

Caution: Clarity requires the cell to provide data, so if the cell is off, button says *Switch On*, it will trigger *NO DATA* error or (in case there is some other detector giving data) *STOPPING* state. Be aware of the fact the External start will start data acquisition even though the cell might be off (button says *Switch On*).

Marker

Invoking this button generates a marker peak in the chromatogram. This function is useful only for analogue plotters as an analysis start marker.

Run Time

Displays the run time of the analysis.

Temperature

Shows the actual temperature in the detector oven of the **Antec DECADE Elite**.

I cell

Shows the cell current of the detector flow cell. The value corresponds to the uncompensated cell current shown on the LCD display of the detector.

V out

Shows the value of the output signal.

E cell

Shows the value of voltage set in the *E cell* field of the [Method Setup - Acquisition - Time Table](#) sub-tab.

This value field is only present in the *DC* mode, it is replaced by the *E1* field in the *Pulse* mode.

E1

Shows the value of voltage set in the *E1* field of the [Method Setup - Acquisition - Time Table](#) sub-tab.

This value field is only present in the *Pulse* mode. It is replaced by the *E cell* field in the *DC* mode.

4.5 Antec Detector Setup

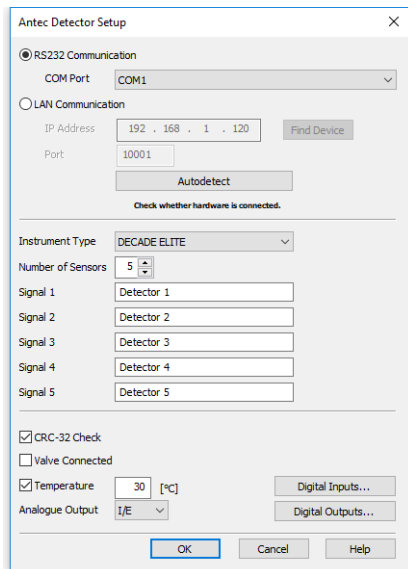

Fig 15: Antec Detector Setup dialog

RS232 Communication

Sets the communication parameters while the detector is communicating over USB.

Note: **Antec DECADE Elite** detector USB port is in fact simulating COM port to be selected in the [Antec Detector Setup](#) dialog.

COM Port

Selects the communication port.

LAN Communication

Sets the communication parameters while the detector is communicating over LAN.

IP Address

Sets the IP Address to connect to the **Antec DECADE Elite** detector. The detector communicating over LAN will use DHCP server settings, but it is possible to set it to fixed IP Address.

Note: Please check the **Antec DECADE Elite** detector manual for the description of how to set the IP Address of the detector.

Port

Sets the communication port for LAN communication. The default communication port is *10001*.

Find Device

Opens a dialog for choosing the IP address from the list of all **Antec DECADE Elite** detector connected to the same network.

Autodetect

This button is used to test the connection to the **Antec DECADE Elite** detector using the previously set communication parameters (either RS232 or LAN). Obtained data gained from the auto-detection are then set in the dialog.

Instrument Type

Shows the type of the connected **Antec DECADE Elite** detector.

Number of Sensors

Displays the number of sensor boards (detectors) that are present in the **Antec DECADE Elite** detector.

Signal 1 (..5)

Fields belonging to particular detectors enable to set the relevant detector names.

CRC-32 Check

Enables the CRC-32 checking of incoming data.

Valve Connected

Enables to control the connected valve.

Temperature

Sets the operation temperature of the **Antec DECADE Elite** detector oven.

Analogue Output

Sets the mode how the **Antec DECADE Elite** detector prepares analog output data. The analog output with the scale of 1V may either be created from the raw data before they are processed by the inbuilt A/D converter (option *I/E*) or after they are processed by the A/D converter (option *DAC*).

Digital Inputs...

Displays the **Digital Inputs** dialog which sets the events performed after particular digital inputs of the **Antec DECADE Elite** detector are invoked. The **Antec DECADE Elite** supports up to 13 inputs (depending on the number of individual sensor boards in the instrument), of which any 8 can be used in the **Clarity** station.

Caution: It is highly recommended to set all unnecessary inputs and outputs to the *Not available* state, as it will significantly speed up the communication.

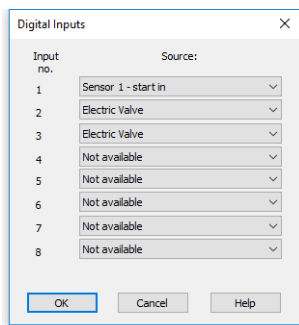

Fig 16: Digital Inputs

Possible events are:

Not available - digital input with this number is not used.

Manual Valve - option for the setting up of a manual injection valve. The manual injection valve has to be connected to the **Valve Connector** located on the back side of **Antec DECADE Elite**. When correctly set in **Clarity System Configuration** the manual injection valve can be used for triggering **Clarity** run if *Ext. Start Dig. Input* set with the same number as Input No. for the manual valve, see ⑧ in **Fig 5** on pg 7.. Note that connected manual injection valve can be utilized also through **Event Table** after selecting of an option for Digital Input from Type column.

Electric Valve - option for the setting up of electric injection valve. The electric injection valve has to be connected to the **Valve Connector** located on the back side of **Antec DECADE Elite** via appropriate RS232 cable. Note the electric valve has to be connected to **Antec DECADE Elite** and switched on before switching **Antec DECADE Elite** on. There are supported two position electric actuators only. When correctly set in **Clarity System Configuration** the electric injection valve can be used for triggering **Clarity** run if *Ext. Start Dig. Input* set with the same number as Input No. for the electric valve, see ⑧ in **Fig 5** on pg 7.. Note that connected electric injection valve can be controlled also through **Event Table** after selecting of an option for Digital Input from Type column.

Sensor 1(..3) - cell on - monitors the signal which turns the corresponding flow cell on.

Sensor 1(..3) - cell off - monitors the signal which turns the corresponding flow cell off.

Sensor 1(..3) - autozero - monitors the TTL signal which sets output signal of the particular cell to 0.

Sensor 1(..4) - start in - monitors the signal which starts a new time file of the particular detector. **Clarity** doesn't use time files.

Note: To be able to start the analysis in **Clarity** when this signal occurs, it is necessary to set the same signal as *Start IN* signal in the [System Configuration](#) dialog.

Digital Outputs...

Displays the **Digital Outputs** dialog which sets the events triggered by particular signals of the **Antec DECADE Elite** detector. The **Antec DECADE Elite** supports up to 6 outputs.

Caution: It is highly recommended to set all unnecessary inputs and outputs to the *Not available* state, as it will significantly speed up the communication.

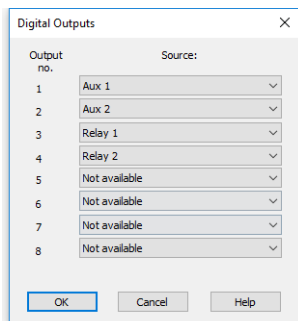

Fig 17: Digital Outputs

Possible events are:

Not available - digital output with this number is not used.

Sensor 1(..5) - aux 1(2) - output providing a free TTL output contact. Two such outputs are available on each detector board.

Sensor 1(..5) - relay 1(2) - output functioning as a relay contact. Two such outputs are available on each detector board.

4.6 Digital Outputs Control

The **Antec DECADE Elite** detector contains six digital TTL outputs from which the first two are also designed as relay contacts. To set the desired events to actual outputs on the back of the **Antec DECADE Elite** detector use the [Digital Outputs](#) dialog described on pg 24.

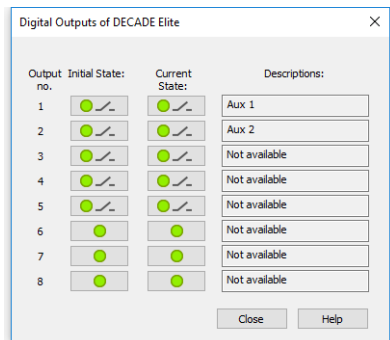
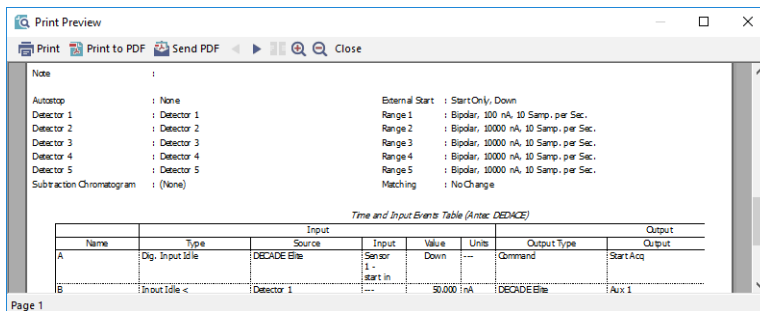

Fig 18: Digital Output Control

This dialog allows to change the *Initial* and *Actual* state of the digital outputs of the **Antec DECADE Elite**. The digital outputs may be also controlled from the [Method Setup - Event Table](#) tab.

5 Report Setup

All of the detector settings accessible on the [Method Setup - Acquisition](#) tab for the given signal are reported. To do so, the *Instrument Control* parameter on the [Method](#) tab of the [Report Setup](#) dialog must be checked.



The screenshot shows a 'Print Preview' window with a toolbar at the top containing 'Print', 'Print to PDF', 'Send PDF', and 'Close' buttons. Below the toolbar, there is a 'Note' section with the following text:

```

Autostop : None
Detector 1 : Detector 1
Detector 2 : Detector 2
Detector 3 : Detector 3
Detector 4 : Detector 4
Detector 5 : Detector 5
Subtraction Chromatogram : (None)
External Start : Start Only, Down
Range 1 : Bipolar, 100 nA, 10 Samp. per Sec.
Range 2 : Bipolar, 10000 nA, 10 Samp. per Sec.
Range 3 : Bipolar, 10000 nA, 10 Samp. per Sec.
Range 4 : Bipolar, 10000 nA, 10 Samp. per Sec.
Range 5 : Bipolar, 10000 nA, 10 Samp. per Sec.
Matching : No Change
  
```

Below the text is a table titled 'Time and Input Events Table (Antec DECADE)'. The table has columns for Name, Type, Source, Input, Value, Units, Output Type, and Output. The data rows are as follows:

Time and Input Events Table (Antec DECADE)							
Name	Type	Input			Output		
		Source	Input	Value	Units	Output Type	Output
A	Dig. Input Idle	DECADE Elite	Sensor 1 - start in	Down	---	Command	Start Acq
B	Input Idle <	Detector 1	---	50,000	nA	DECADE Elite	Aux 1

Page 1

Fig 19: Report Setup

6 Troubleshooting

When the remedy for some problem cannot be discovered easily, the recording of communication between **Clarity** and the detector can significantly help the **DataApex** support to discover the cause of the problem.

The recording can be enabled by adding or amending the COMMDRV.INI file in the **Clarity** installation directory (C:\CLARITY\CFG by default). The file can be edited in any text editor (e.g. Notepad). Following section should be edited or added:

```
[COM1]
echo=on
textmode=on
filename=AntecDecadeElite_%D.txt
reset=off
```

Note: Instead of COM1 type the correct port used to communicate with the **Antec DECADE Elite** detector. This port number is displayed when the *Det Status* button in the [Method Setup - Acquisition](#) dialog is invoked.

Note: %D (or %d) in the filename parameter means that the log will be created separately for each day. The *reset=off* parameter disables deleting the content of the log each time the station is started during the same day.

The created *.TXT files will greatly help in diagnosis of unrecognized errors and problems in communication.

6.1 OTHERS.INI File Setup

In the OTHERS.INI file (by default located in the C:\CLARITY\CFG directory) user can create section [DecadeII] containing keys, which are influencing the way Clarity deals with missing timestamps in incoming data. The section can contain following keys:

timestamps

Defines what action the control module will do in case missing timestamps problem appears.

Values:

- 0 - to ignore missing timestamps (Default)
- 1 - to record missing timestamps into chromatogram audit trail
- 2 - to calculate and record missing timestamps

start

Defines when the module will start do action from "timestamps"

Values:

- 0 - Starts from first timestamp, and first expected timestamp is 1 (Default)

- 1 - the first timestamp will store and starts from second timestamp
- 2..X - the X timestamp will store and starts from X+1 timestamp

length

Defines maximal count of missing timestamps, which are considered as error

Values:

- 0 – any number of missing timestamps are considered as error (Default)
- 1..X - number of missing timestamps exceeding this value will not be considered as error

Example of section (can be directly copied/pasted to OTHERS.INI):

[Decadell]

; What to do with missing timestamps

**; 0 - Ignore, 1 - Record in audit trail, 2 - Calculate and record
timestamps = 0**

; When to start executing action set in previous key

**; 0 - From first missing, X - From X+1 missing
start = 0**

; Maximal count of missing timestamps considered as error

**; 0 - Any number, X - number of missing timestamps exceeding this
value will not be considered as error
length = 0**