

Science with Passion



AZURA[®] Preparative HPLC



Configure the best possible system for your purification workflow of peptides, oligonucleotides, RNA, cannabis and many other API with the market-leading AZURA preparative HPLC platform.

think **LC.** think **KNAUER.**

AZURA® Preparative HPLC

Customized purification

AZURA® preparative systems are the perfect solution for frequently changing separation tasks - from milligram to kilogram scale. Design your AZURA preparative system to your needs and combine flexibility and reliability.

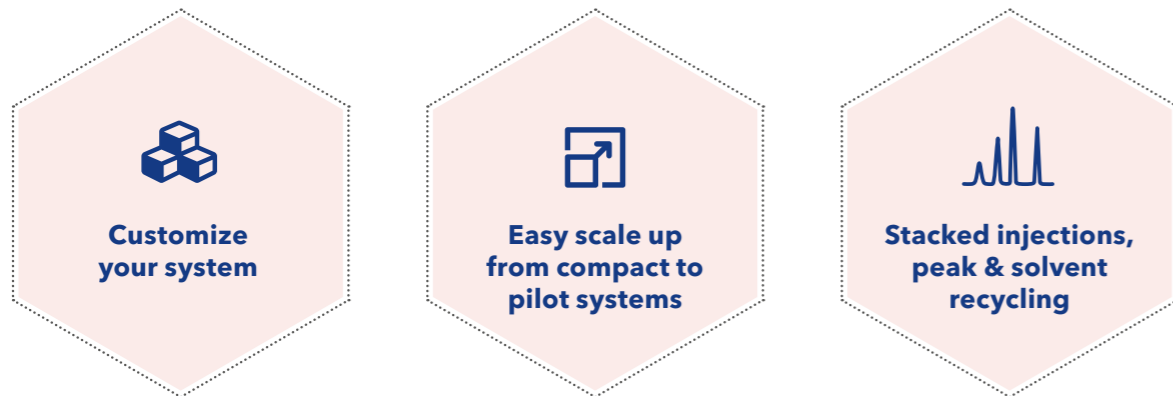

AZURA® Prep systems are tailor-made for you. Configure your system from injection to detection and choose between different materials, flow rates, valves and detectors.

Due to the flexible design of our devices, you can easily change parts like pump heads or flow cells and integrate all components of the compact into the pilot-scale system.

AZURA® Prep systems can be used for special separation modes like peak recycling and stacked injections. We help you to configure your system and choose the best software for you.

Purification strategy: Prioritize purity, throughput or yield?

The dependencies between throughput, purity and yield always have to be considered in HPLC purifications. Whatever priority you decide for, with the AZURA preparative systems you can successfully adapt.

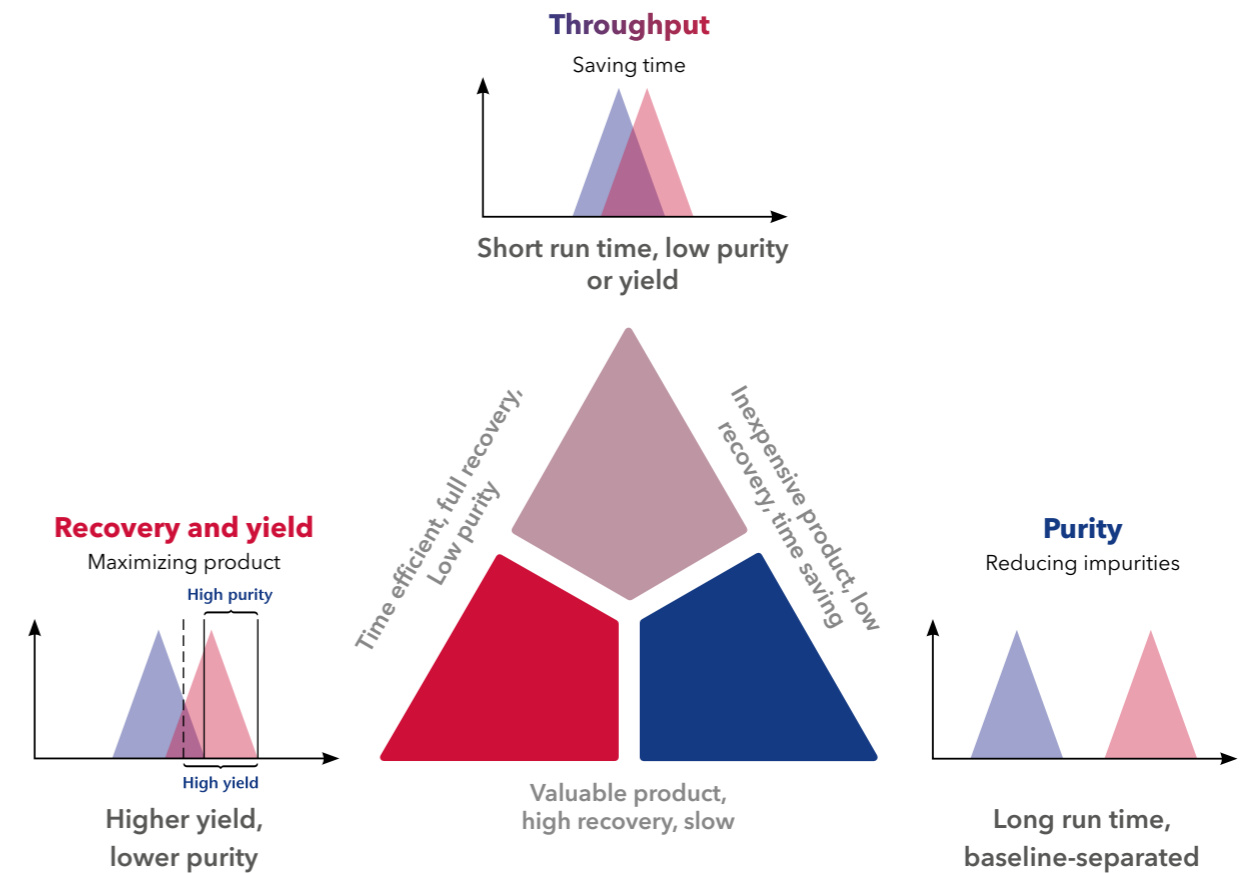

High purity and high yield with continuous chromatography

The AZURA SMB systems are the solution for your continuous purification task. Get higher productivity and purity than with comparable batch systems. Save up to 90 % of the solvent and reduce the solid phase costs up to 80 %.

For more information see page 37.

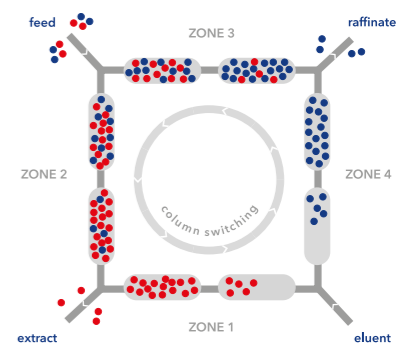

Scheme of SMB principle

Preparative chromatography

The general objective of preparative chromatography is to isolate, purify and collect your target compounds. Preparative applications are often initially performed on an analytical level and need to be upscaled. Depending on the desired scale, the requirements for a preparative system differ in eluent supply, sample injection, column, and detection. We customize our systems to meet your chromatography scale-up and purification challenges. Benefit from our experience in preparative chromatography.

For more information: www.knauer.net/prep

Flexibility and performance

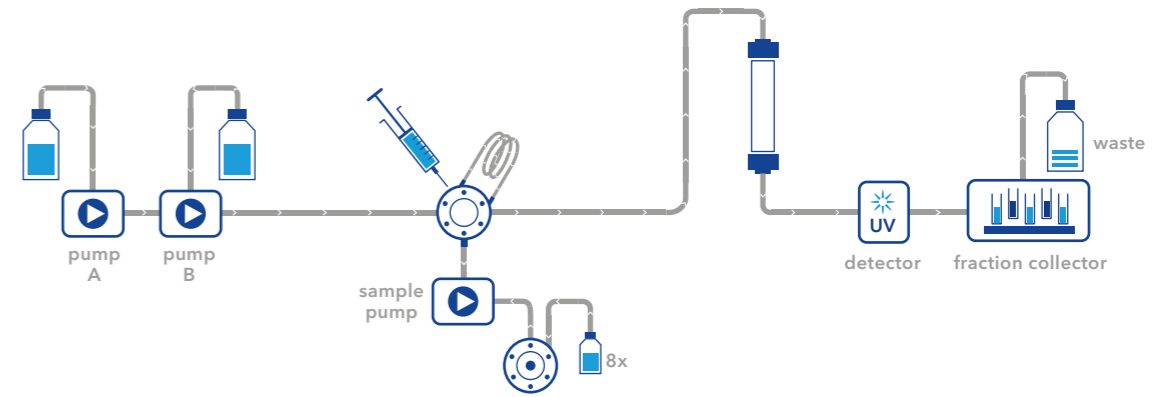

ELUENT DELIVERY **SAMPLE INJECTION** **COLUMN SELECTION & THERMOSTAT** **DETECTION**

HPLC module docking station

Customizable combination of valves, detectors and pumps in one housing e.g. for sample injection (see page 10)

Fiber optics flow cell

Measure close to the column to minimize peak broadening with fiber optics (see page 21)

HPLC column

Preparative separation columns (see page 19)

Multi Column Base

Securely position up to three preparative columns, customize and organize your system with a wide range of accessories (see page 28)

Sample selection and injection

Automated injection: use a valve or a valve with feed pump (see page 11 + 12)

Mobile Control

Optional touch display and control tool for AZURA systems (see page 27)

Detection

Various detector types (UV/VIS, DAD, RI, FL, MS) and a selection of flow cells for a wide range of flow rates (see page 20)

Fraction collection

Fractionation valve or fraction collector for various flow rates (up to 1000 ml/min) (see page 15)

Eluent delivery

A choice of pumps with pump heads available in different materials allows maximum flow rates from 50 - 1000 ml/min. Isocratic, low and high pressure gradient forming are possible (see page 8)

Most flexible system solutions on the market

High or low pressure gradient 50 - 1000 ml/min

User friendly and powerful software

AZURA® Preparative HPLC

Upscaling from compact to pilot

The modular AZURA Preparative HPLC platform offers you the opportunity to build a purification system best suited to your needs.

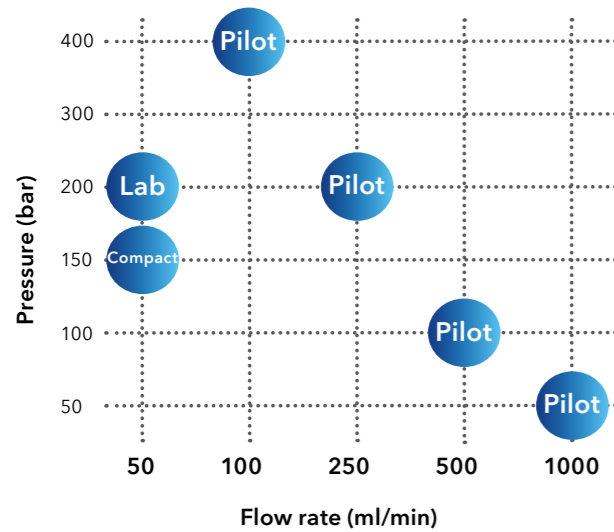

AZURA® Compact Prep LC

Flow rate max. 50 ml/min*
Isocratic



AZURA® Lab Prep LC

Flow rate max. 50 ml/min*
Isocratic/HPG



AZURA® Pilot Prep LC

Flow rate max. 1000 ml/min*
Isocratic/LPG/HPG

AZURA system	Available pump heads Max. flow rate in ml/min*					Gradient options	
	50	100	250	500	1000	LPG low pressure	HPG high pressure
AZURA Compact Prep LC	•						
AZURA Lab Prep LC	•						•
AZURA Pilot Prep LC		•	•	•	•	•	•

* Information on best working conditions on pages 8 - 9.

Scale-up from compact to pilot

The AZURA Pilot Prep LC is the ideal solution for your upscaling tasks. The 100 ml pump head allows you to run your system under analytical conditions before adapting your method to preparative scale.

For more information:
www.knauer.net/prep

Eluent delivery

Precise and reliable pumps covering a wide flow range for various gradient and solvent selection options.

AZURA® Pump P 2.1L

The preparative HPLC pump AZURA P 2.1L covers a wide flow rate and pressure range. It has been designed for the purification of milligram to gram samples. The integrated automatic RFID pump head recognition allows a quick adaptation to various applications.

- **Flow rate** up to 1000 ml/min
- **LPG** and **HPG** gradient options
- Supports **constant pressure mode**

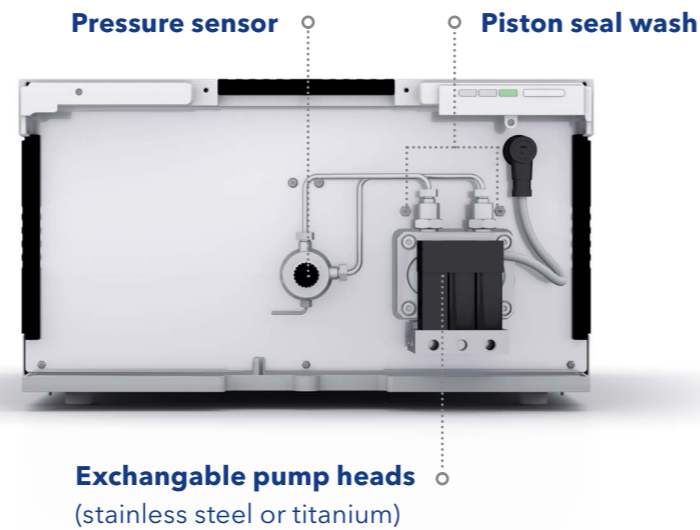

Gradient options of Pump P 2.1L

A **low pressure gradient (LPG)** module dynamically composes the eluent on the inlet-side or low pressure side of the pump head, by quickly switching between the different solvent channels. We offer binary or ternary LPG upgrade modules for the isocratic P 2.1L.

The eluent in a binary **high pressure gradient (HPG)** system is composed by combining the solvent flows of two isocratic pumps.

Pump head	Max. pressure	Best working conditions
100 ml	400 bar	1 - 80 ml/min
250 ml	200 bar	2.5 - 200 ml/min
500 ml	100 bar	5 - 400 ml/min
1000 ml	50 bar	10 - 800 ml/min

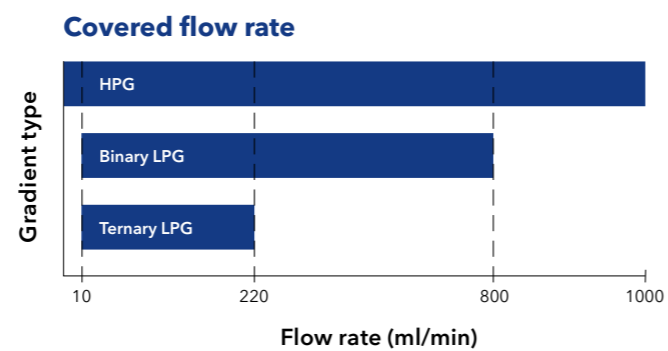

AZURA® Pump P 6.1L

The AZURA semi-preparative pump P 6.1L with 50 ml pump head is available as an isocratic or binary HPG pump. It is made for medium-size purification tasks and upscaling processes.

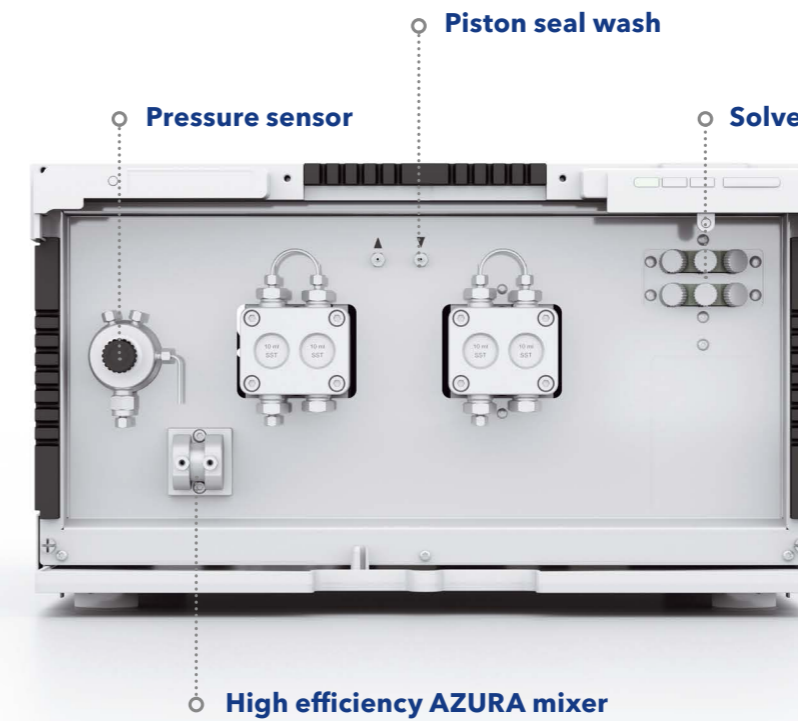

- **Flow rate** up to 50 ml/min
- Best working conditions: **0.1 - 40 ml/min**
- **Binary gradient** with solvent selection valve (2x2 solvents)
- Up to **300 bar** < 10 ml/min
- Up to **200 bar** max 50 ml/min

Solvent selection

For automated solvent change, a solvent selection valve can be attached to the pump P 2.1L.

For semi-preparative purification tasks, the pump P 6.1L features a built-in 2x2 solvent selection valve (high pressure gradient version).

TECH TIP

- > 1/8" tubing up to 80 ml/min
- > 1/4" tubing up to 1000 ml/min

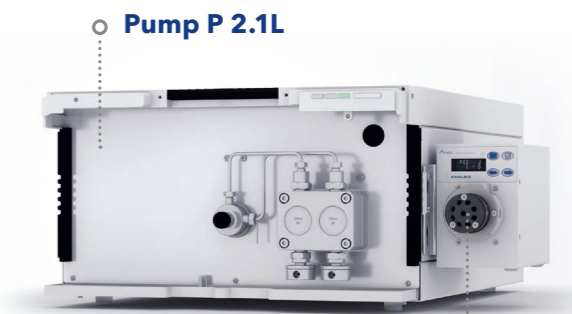

Solvent selection valve for different solvents

Docking station for pumps, valves and detectors AZURA® Assistant ASM 2.2L

The Assistant ASM 2.2L is a docking station for three compact devices. Valves, pumps and UV detectors can be combined in one housing. The plug-in modules are removed by loosening four screws allowing the user to exchange modules in case of service within minutes. Likewise, the configuration of the HPLC system can be adapted to new requirements. Routine maintenance work e.g. replacing the lamp of a detector is easily performed by the user.

Depending on the integrated modules the assistant fulfills many different tasks like eluent delivery, detection, sample and solvent selection, sample injection, column switching or fraction collection. An assistant including a pump, injection valve, and detector features a complete HPLC system, like AZURA Compact Prep LC. As a part of a larger system, the ASM 2.2L allows the user to customize the system configuration according to the purification challenge.

Pumps

Choose from 15 different pumps with 10 or 50 ml pump heads and with or without pressure sensor. The material used is stainless steel, ceramic or Hastelloy C (for pumps without pressure sensors only).

Valve drive

The universal valve drive identifies valves via RFID technology and enables to read GLP data. All V 4.1 valves, independent of number of ports and position, are supported.

UV detectors

The compact single wavelength UV detector is available in a basic and fibre optics version. The wavelength can be set between 190 - 500 nm.

Freely combine pumps, valves and detectors in one housing

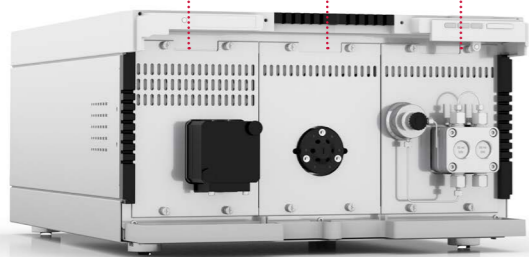

Configure your assistant

Use the web-based assistant configurator to find your desired AZURA® ASM 2.2L module combination:

www.knauer.net/assistantconfigurator



Sample injection

Adapt the sample injection mode to your preparative task.

Injection valve

The simplest way to inject your sample into the system. Use a manual injection valve and choose from a large range of different sample loops.



KNAUER offers several injection valves for 1/16" and 1/8" tubing. The wetted parts are made of stainless steel or PEEK to cover a broad range of applications. Injection can be done either manually via hand lever or automated with a valve drive.



The Multi-Injection valve for 1/16" tubing enables the sample injection via loop and sample pump through just one valve, perfect for often changing applications.



VariLoop for sample injection

The KNAUER VariLoops are the perfect solution for the injection of medium up to high sample volumes (up to 40 ml). The sample loop can be emptied completely or partially as well as filled completely

or partially. This allows you to work very flexible and easily switch between different sample sizes while keeping constant and reproducible injection volumes for every sample size.

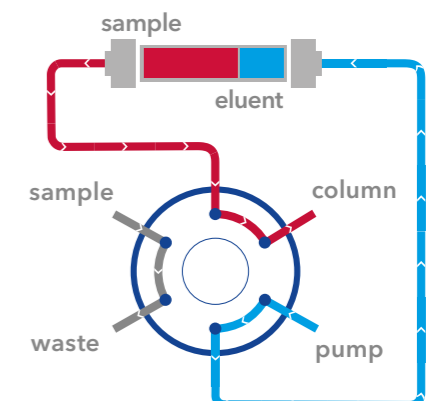
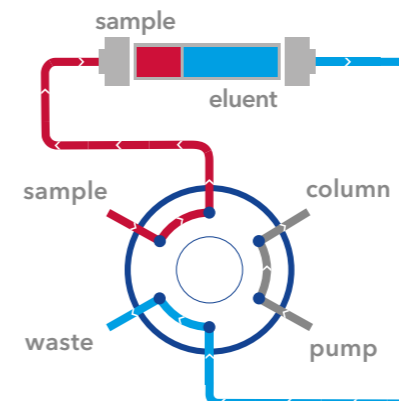

Autosampler AS 6.1L

Sample injection can be easily automated with an autosampler. The AS 6.1L can inject up to 10 ml per injection. Sample tray temperature control from 4 - 40 °C is optional available. It can handle either 30 samples in 10 ml vials or up to 768 samples in well plates.

Automated sample injection also possible with Liquid Handler LH 2.1. More information on page 14.



Sample Injection Assistant ASM 2.2L

The AZURA Sample Injection Assistant is based on the docking station for HPLC modules ASM 2.2L. It is designed to automate injection of larger sample volumes and features a sample selection valve, a sample pump, and an injection valve.

Simply attach your sample vessels via 1/8" tubing to the multiposition valve and automate injection with the integrated sample pump and injection valve.

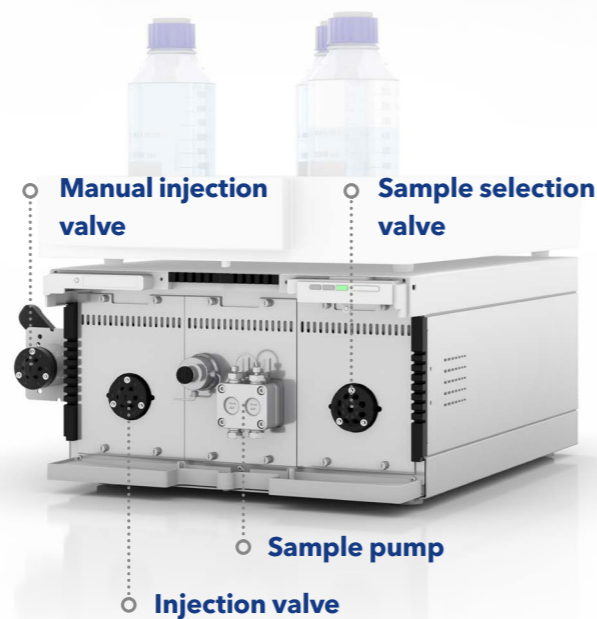

Sample pump

Standalone or as a plug-in module of the HPLC dockingstation ASM 2.2L: The compact pump AZURA P4.1S is perfect for feed injection.

- 10 and 50 ml **exchangeable pump head**
- **Flow rate** range:
0.01 - 50 ml/min (50 ml pump head)
0.001 - 10 ml/min (10 ml pump head)
- Pump heads available in **stainless steel** or **ceramics**
- Best working conditions:
1 - 40 ml/min (50 ml pump head)
0.1 - 8 ml/min (10 ml pump head)



Automation for prep HPLC

Eluent selection and fractionation

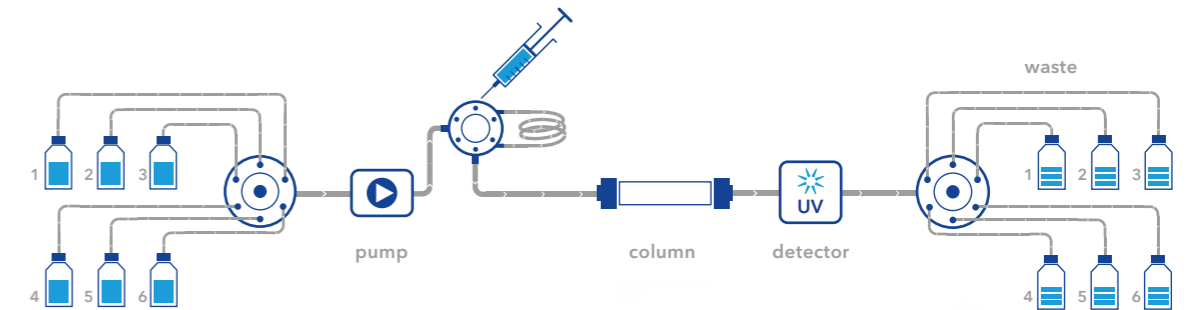

When automated selection of eluents is required, up to 12 different eluents can be attached to the preparative system. Multiposition valves fulfill many different tasks: solvent and sample selection, fractionation and column switching.



Multiposition valve

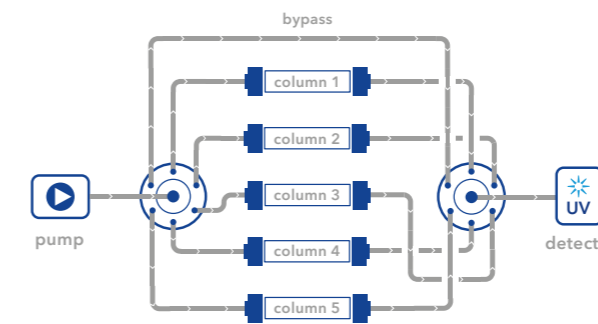

Example for the selection of 5 columns

Column switching

Switching valves are ideal for screening and scale-up. They can be easily integrated into your system at pressures up to 400 bar and maximum flow rates of 300 ml/min. Up to 16 columns can be selected.

Stacked injection

With the stacked injection function, it is possible to perform different runs automatically one after the other. The injection of the next run takes place during the current run, so that the time until the elution of the first peak can be fully exploited. This increases efficiency, saves time and eluent. Stacked injection can be operated with the chromatographic data systems (CDS) PurityChrom® and OpenLab®.

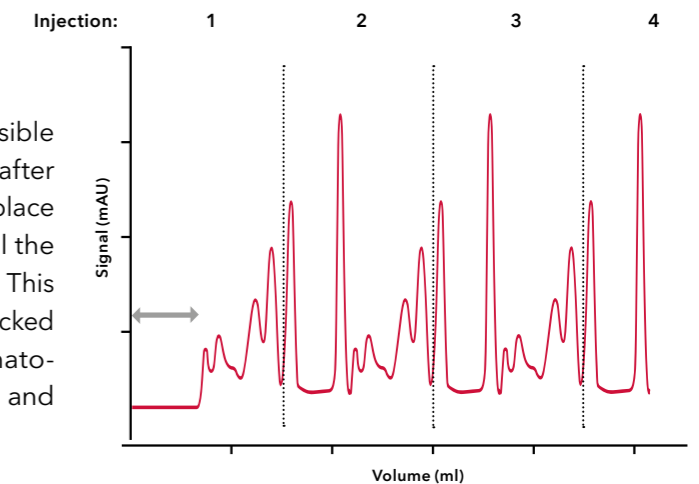

Liquid Handler LH 2.1 - Injector & Fraction Collector

KNAUER's new Liquid Handler LH 2.1 allows for the expansion of purification processes with the ability to combine sample injection and fraction collection in one device. A high capacity of sample and fraction vessels meets a flexible arrangement

facilitating reinjection of samples to reach new levels of purification. The handler injects samples with minimal loss regardless of their volume - perfect for working with expensive compounds.

- **Combine** sample injection and fraction collection
- **Scalable** injection range up to 60 ml
- **Purify** from milligrams to several grams
- **Flexible** arrangement of samples and fractions via teaching option
- **Reinject** collected fractions
- **Perform** in high-throughput peptide and oligonucleotide workflows

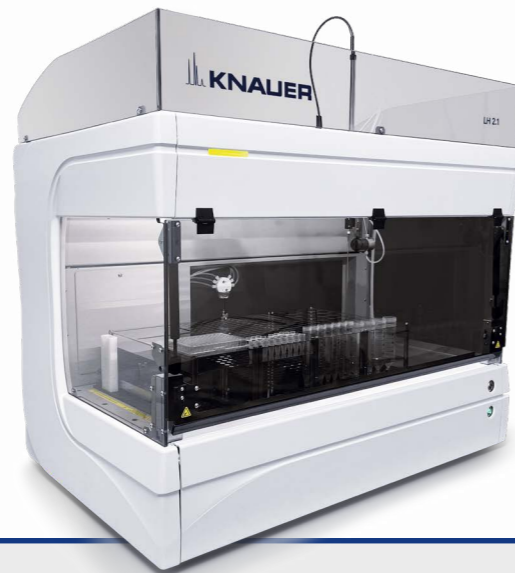

Technical data

Fraction collection	
Fraction capacity	Maximum vessel capacity with 5 KNAUER racks <ul style="list-style-type: none"> • 15 x micro titer well plates • 810 x 2 ml tubes • 490 x 15 ml tubes • 160 x 50 ml tubes
Diverter valve	yes
Number of racks	5 KNAUER racks, teaching module for all racks
Sample injection	
Sample injection	standard and sandwich injection mode
Sample loop	up to 60 ml; larger loops on request
Injection valve	1/16" or 1/8" V 4.1 injection valves and VU 4.1 supported
Temperature control	no
Needle wash	single needle wash step after each injection
Wash solvents	4
Wetted materials	Aluminium oxide 99.5 %, Borosilicate Glass, PTFE, FEP, AISI 316L, PEEK

Fraction collection

Collect large quantities or large numbers of fractions

KNAUER offers different valves for fraction collection and variations of trusted fraction collectors. Whether you are doing research and development or production, there is an appropriate solution that suits your application.

Fractionation modes:

Manually - collection by direct control

Time-based - collection at defined time points

Peak-based - collection according to detector signal

Threshold function - collection according to any signal

Fraction collectors

LABOCOL Vario 4000 / Plus

The LABOCOL Vario 4000 fraction collectors are characterized by their high robustness and optimal ratio of dimensions/benefit. The user is not limited to given rack types. The rack layout can be designed according to individual needs. Free rack design. Any rack type can be integrated by de-

fining the number of fraction vessels and their position. The wide application area makes the Vario 4000 series ideal for use in research and development as well as in production. The Vario 4000 models differ in the base area and the flow rate range.

Rack type

80 Tubes 18 mm / max. 36 ml

125 Tubes 10.5 mm / max. 9 ml

20 Tubes 36 mm / max. 140 or 240 ml

39 Tubes 26 mm / max. 80 ml

24 Centrifuge tubes 50 ml



Foxy® R1

The Foxy® R1 fraction collector can be adapted to a broad spectrum of applications. Flow rates of up to 125 ml/min are possible. Fractions can be collected into 96 well microplates, standard tube sizes, bottles and many more. For essentially unlimited volumes, funnel racks can direct fluids to any collection vessel or downstream process. Both devices can be operated stand-alone or in the chromatography software PurityChrom®.

Rack type
144 Vials 13 mm / max. 9 ml
100 Vials 16 mm / max. 20 ml
36 Vials 25 mm / max. 70 ml
2 Microwell plates 96
60 Tubes 1.5 ml
72 Centrifuge tubes 15 ml
36 Centrifuge tubes 50 ml
36 Funnels with vinyl tubing



Fractionation also possible with Liquid Handler LH 2.1. For more information see page 14.

Fractionation valves



8 Port Multiposition valve
for 1/8", SST
7 fractions + waste



12 Port Multiposition valve
for 1/8", SST
11 fractions + waste



16 Port Multiposition valve
for 1/16", SST
15 fractions + waste

Fractionation valves max. flow rate (in ml / min)

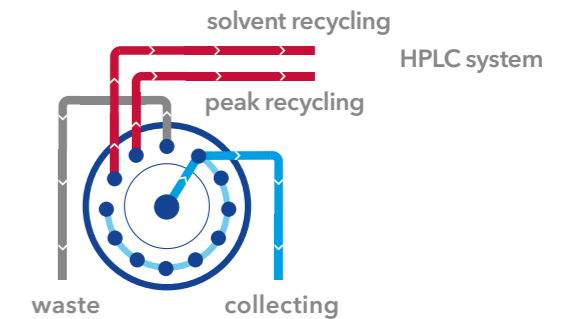
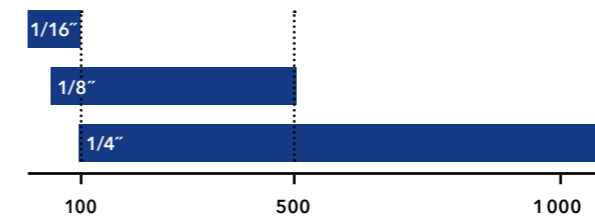

Device	Max. flow rate (ml/min) 1/16"; 1/8"; 1/4"	Racks	Different rack types	Max. fractions 1/16"; 1/8"; 1/4"
Valve	100 / 500 / 1000			16 / 12 / 10
Foxy R1	25 / 125 / -	1	8	up to 144
Vario 4000	100 / 500 / 1000	3	5**	72*
Vario 4000 Plus	100 / 500 / 1000	5	5**	120*

TECH TIP

For contamination free collection, the combination of two valves is perfect especially as - the PurityChrom software is able to address the matching delay volume to each valve.

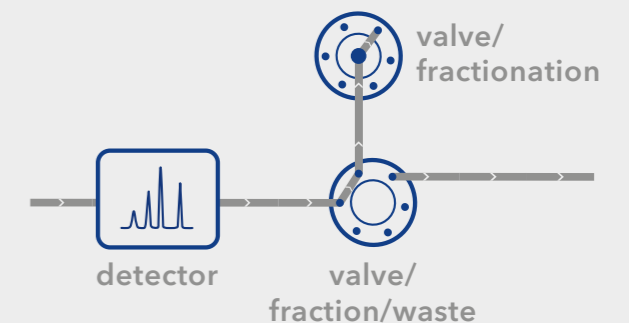

* For 50 ml tubes

** Device supports other racks via user-defined position setting.

Advanced Purification Modes

An example

A separation can be much more demanding after upscaling from analytical to preparative scale. In many cases a baseline separation is not possible anymore, so time and money consuming method development or hardware adjustments are necessary. The AZURA Prep LC system is well-suited to apply the peak recycling technique to solve demanding resolution tasks. Additionally, solvent recycling can be applied to save eluent, if it can be considered clean.

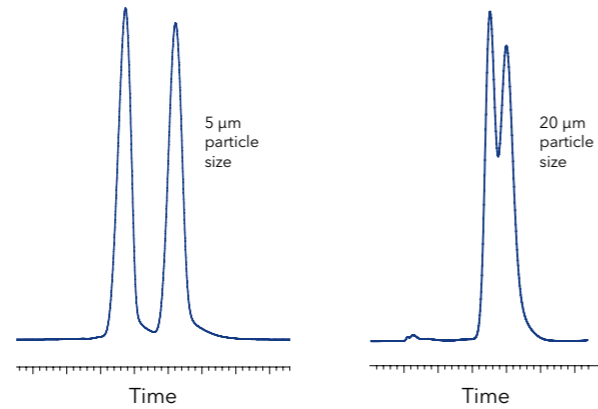

Comparison of analytical and preparative chromatogram.

Collecting mode

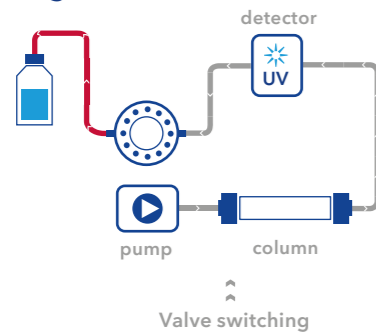

Recycling mode

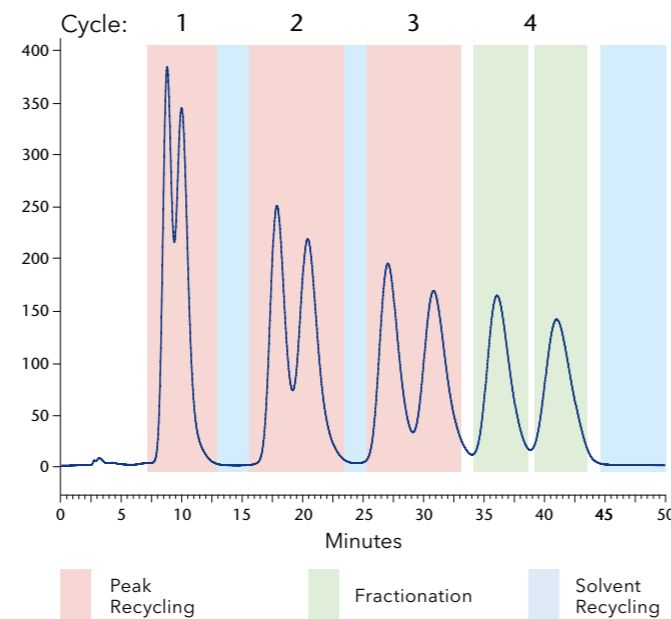
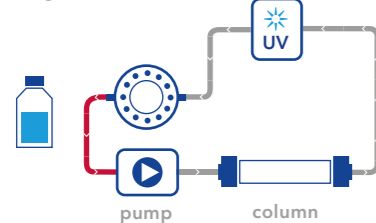

Successful peak separation with recycling mode.

KNAUER preparative columns

Find the perfect column from the large KNAUER portfolio.

This flow chart gives you a guideline how to select the right column for your application. Start at the top and follow the decision lines all the way down to find a column recommendation.

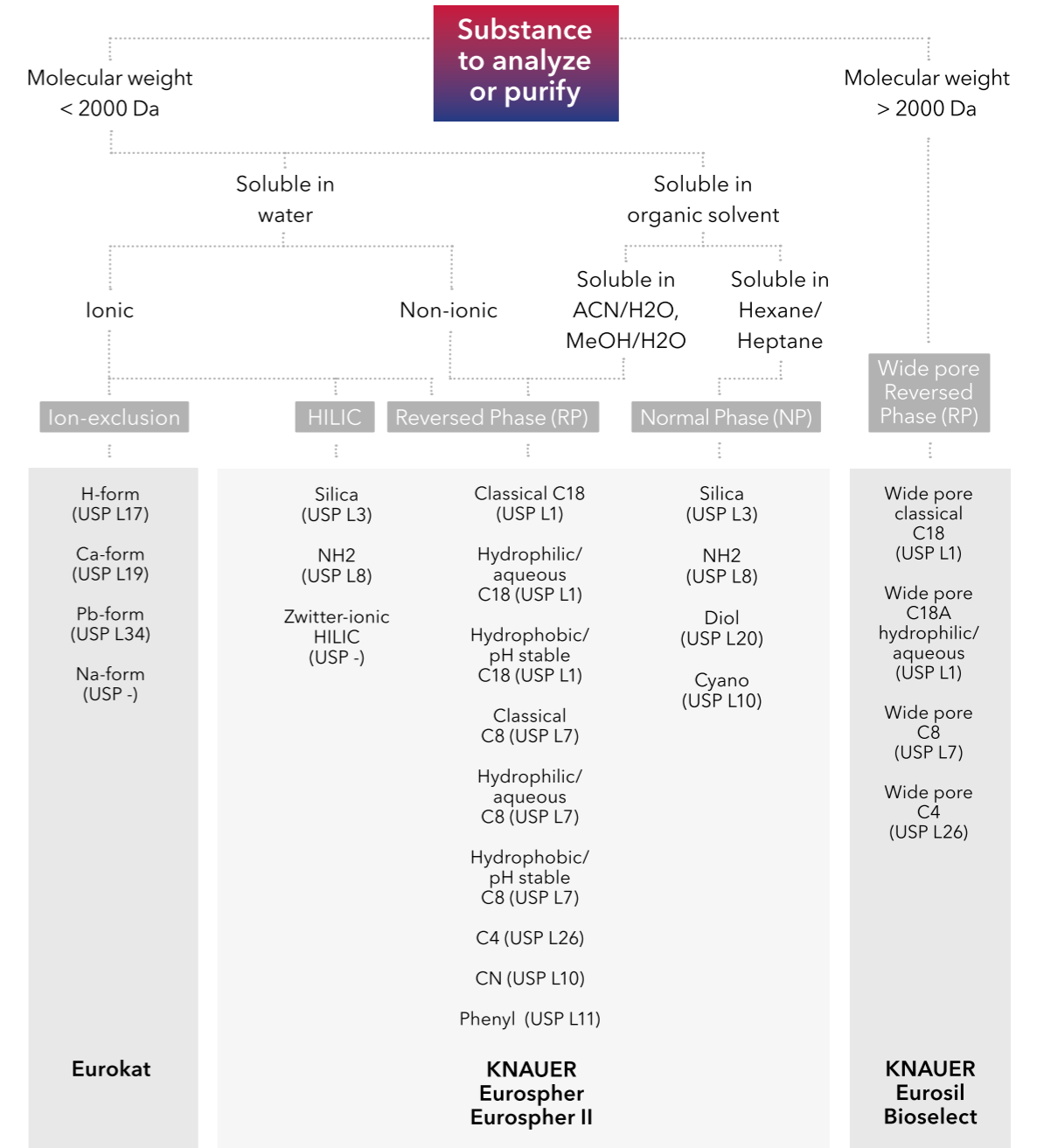

Application Note (VTN0005)

Comparing sensitivity levels for the analysis of fluorescence-labeled proteins
www.knauer.net/applications



KNAUER Column Selection Guide

For more information on the KNAUER column portfolio visit:
www.knauer.net/columns

Detection

KNAUER gives you the opportunity to analyze nearly every compound due to a large portfolio of HPLC detectors. For the achievement of your analysis goals and for matching your separation scale, our detectors are flexible in the setup, including flow cells and fiber optics. Our product line of UV/VIS detectors ranges from single variable wavelength to 8-channel diode array detectors with 3D scan capability.



Detector	UVD 2.1S	UVD 2.1L	MWD 2.1L	DAD 2.1L	DAD 6.1L
	Compact and versatile UV detector	Reliable UV/VIS detector for a wide spectrum of applications	Robust multi-channel UV/VIS detector	Versatility through a wide flow cell range	High-end diode array detector with outstanding performance
Wavelength	190-500 nm	190-750 nm	190-700 nm	190-700 nm	190-1000 nm
Channels	1	1	4	8	8
3D scan				•	•
Fiber optics available	•	•	•	•	•

Flow cells for UV/VIS and DAD detectors

Select from an impressive range of easily exchangeable preparative and semi-preparative flow cells for UV/VIS and DAD detectors. With capillary connections ranging from 1/16" to 1/4" and TRI-Clamp adaptations, optional fiber optics technology and a variety of flow cell wetted materials, a wide spectrum of applications can be covered.

Max. flow rate	Connectors	Path length	Volume	Max. pressure	Fiber optics available
50 ml/min	1/16"	3 mm	2 µl	300 bar	•
250 ml/min	1/16"	0.5 mm	3 µl	200 bar	•
1000 ml/min	1/8"	0.5/1.25/2 mm	1.7/4.3/6.8 µl	200 bar	•
10000 ml/min	1/4"	0.5/1.25/2 mm	1.7/4.3/6.8 µl	200 bar	•

Fiber optics technology

More flexibility

Fiber optic cables offer the possibility to separate the flow cell from the detector. This enables demanding applications such as measuring directly after a heated LC column or in hazardous environments, allowing safe operation of the instrument while maintaining performance.

Safe operation

When working at high flow rates, separation of the flow cell and the detector is a safety feature. In case of leakages, no damage to the detector occurs. Fiber optics are available in a customized length of up to 10 meters.



Flow cell with 1/4" TRI-Clamp connection

AZURA® RID 2.1L HighFlow Preparative refractive index detector

The AZURA RID 2.1L HighFlow is a sensitive and competitively priced differential refractometer. It is suitable for detecting compounds with little or no UV activity such as alcohols, sugars, lipids or polymers in high concentrations. This instrument is designed for use in semi-preparative and preparative HPLC for flow rates up to 100 ml/min. Optional are higher flow rates possible with a flow splitter. The intelligent temperature control guarantees fast baseline stabilization and stable operation.



Application Note (VPH0068)

Cyclodextrin purification Part 2 - Method transfer and purification
www.knauer.net/applications



Special detection

Choice of specialized detection technology, fully integrated in PurityChrom®. Suitable for preparative LC with the help of a flowsplitter.

Light Scattering Detector Sedex LC

Sensitive universal detection with the possibility to run gradients

As a universal detector, an ELSD detector offers numerous possibilities for detecting substances that have few or no chromophores. Since the eluents are evaporated, the use of non-UV-compatible solvents poses no problems and the ELSD is gradient compatible.

Target analytes: Carbohydrates and similar compounds, detergents, ionic and non-ionics, artificial sweeteners, antioxidants, amino acids, lipids, peptides, polymers, pesticides, proteins, steroids.



AZURA® Conductivity Monitor CM 2.1S

The Conductivity Monitor CM 2.1S can monitor salt gradients with flow rates of up to 100 ml/min and a maximum pressure of 100 bar. It supports a wide measurement range of 0.01 mS/cm - 999 mS/cm. Flow cells in PEEK for both analytical and preparative scale are available.



pH option available

Mikron 81 Conductivity Monitor

The mikron 81 is a reliable in-line conductivity monitor with a very low footprint and measures with high linearity in the range from 0.002 to 500 mS/cm. Its cutting-edge temperature sensor technology enables highly precise automated temperature correction of the conductivity signal. The intelligent flow cell design allows for a broad flow rate regime from microliter to lower liter per minute scale. It comes pre-calibrated and ready-to-use with all accessories needed. Accordingly, the mikron 81 can be used to monitor salt gradients during purification or cleaning-in-place procedures as well as for upscaling (eg. from 1 ml/min to 1 l/min).



Mass spectrometry solution by KNAUER

KNAUER offers several system solutions for mass triggered preparative chromatography applications. Systems can be operated using the Chromeleon™ or PurityChrom® software.

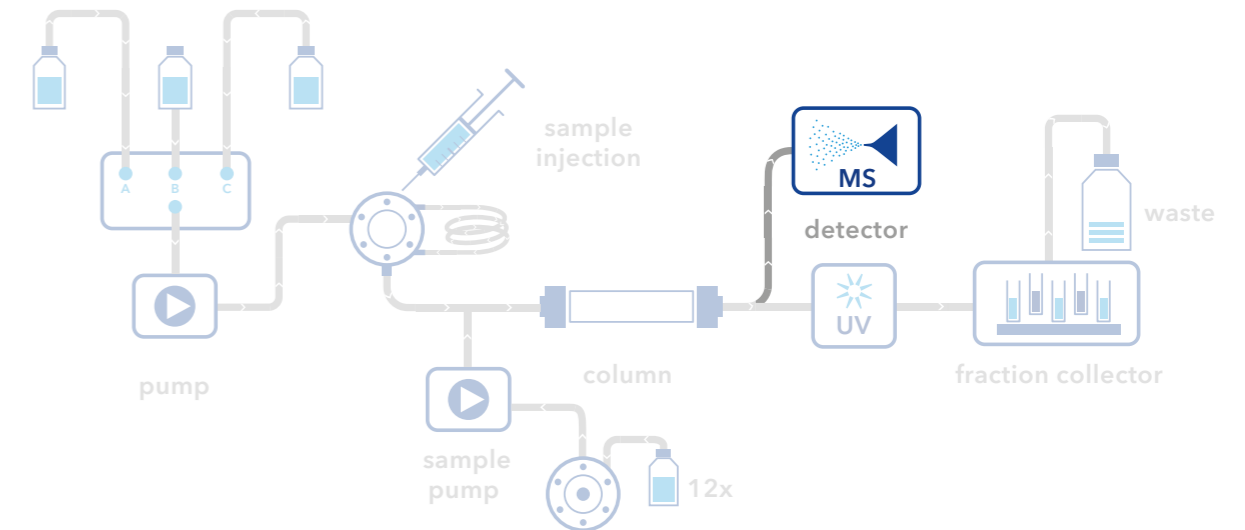

The mass-controlled fractionation allows the selective isolation of substances that are not UV active. Furthermore, in combination with a UV detector and intelligent and/or algorithms, high purities can be achieved even with very difficult preparative separations.

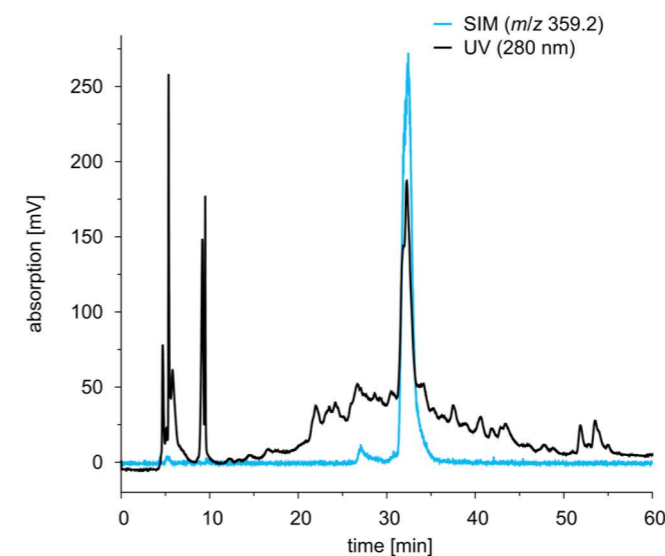

Purification of a natural product by mass directed fractionation

Black: UV trace at 280 nm
Blue: MS trace (SIM) for target compound

Temperature control

Increase performance. Minimize solvent viscosity.

Eluent and Column Heater

When performing preparative LC at temperatures above 40°C in air-conditioned laboratories e.g. in RNA purification processes, a uniform temperature distribution is essential. With the Eluent Heater, solvent temperature can be precisely controlled using the integrated touchscreen. It supports flow rates of up to 500 ml/min and is cleanroom compatible.



Column Heating Sleeve

Our column heating sleeves are the perfect solution for thermostating your preparative column hardware. Available for all preparative KNAUER column dimensions at temperatures up to 100 °C. Custom dimensions, clean room compatible and autoclavable materials are available on request.



Column Oven

This oven can heat up to 80 °C. It can accommodate up to 8 KNAUER columns with up to 250 x 50 mm inner dimensions.



Pump Head Heater

Electrical heating element for pump heads. Temperature can be controlled using the eluent heater or a single device control unit.



Software solutions

PurityChrom® 6

PurityChrom is a powerful software to control your purification system. With its revised, modern user interface, new powerful features and improved useability, PurityChrom 6 is a new generation of

our purification software PurityChrom. The software is developed according to GAMP 5 guidelines and is 21 CFR part 11 compliant.

Animated flow path

See exactly what you are doing and easily avoid mistakes with the animated flow path. Device functions for example starting the pumps, setting

the flow rates, switching the valves, change the wavelength of your UV detector are available via pop-up menus in the system visualization.

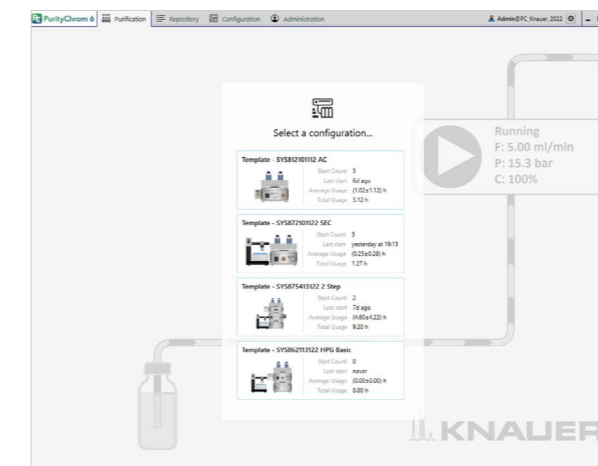
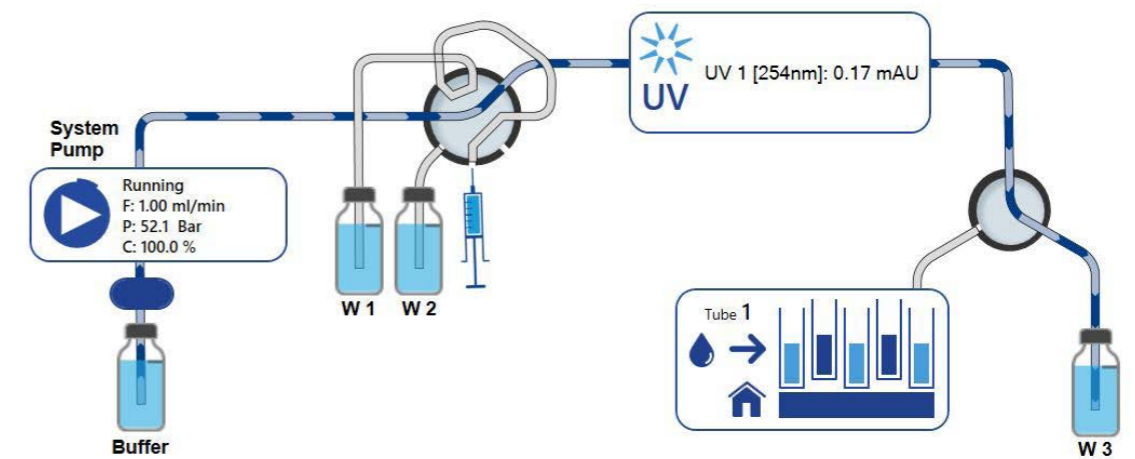

Configuration of multiple systems

PurityChrom 6 is as flexible as our KNAUER hardware. Multiple set ups can be configured in the software, e.g. configure the system with heating devices and without them, for all purification tasks that do not require temperature control.

Method writing with just a couple of clicks

In PurityChrom 6, methods can be written by simply clicking in the system visualization. Furthermore, a graphical editor enables a comparison between the current method and a previous chromatogram.

Methods can be created based on volume, column volume or time, depending on your preference. All solvent, waste and sample bottles can be configured and fill levels and solvent consumption are calculated, offering extra security during operation.

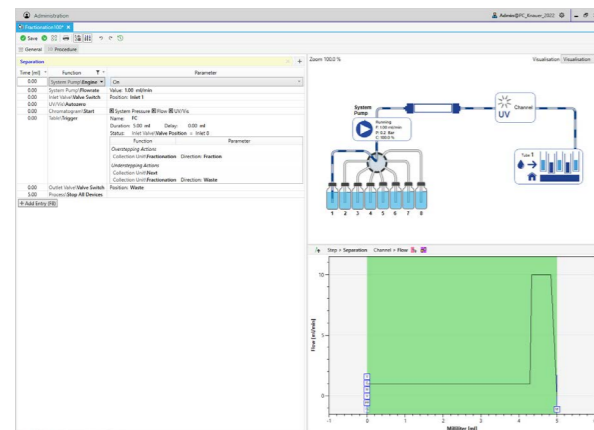
**Advanced user administration**

In PurityChrom 6, users can be assigned to a role simplifying the administration of a high number of users. An audit trail summarizes all actions of all users. Additionally, each chromatogram contains a run protocol summarizing the functions and events occurring during the method

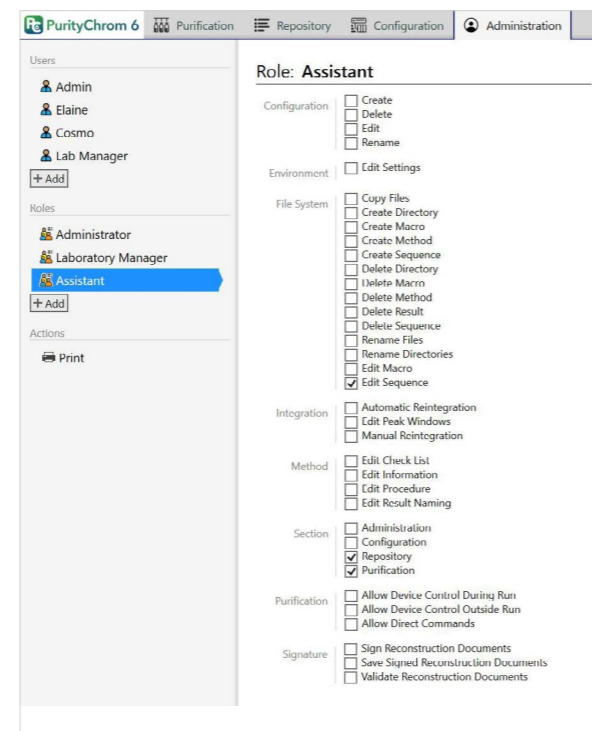
**ClarityChrom® CDS**

ClarityChrom is an easy-to-use chromatography data system (CDS) for workstations. Besides support of all KNAUER devices, components and systems from more than 45 manufacturers are also supported. ClarityChrom® includes the drivers for several fraction collectors and supports peak recognition by level and/or slope. The manual fraction control and the option to use the KNAUER electric valves for fractionation give you even more flexibility.

- Fraction collecting via peak recognition (level only, slope only, level AND / OR slope - incl. self-learning) or single event (unconditional, timed event)
- Easy to collect: waste, collect to position / collect to next, solvent recycling
- Direct control during a run - manually switch to: collect, waste, solvent recycling
- Consecutive runs: easily find your chromatogram by clicking on your fraction

OpenLab

OpenLAB CDS EZChrom Edition provides support of devices from KNAUER and many other manufacturers. The KNAUER fraction collector control option includes the drivers of several fraction collectors and supports fractionation by time, the peak recognition by level and/or slope, also with spectral confirmation. Collect Slices allows for setting a desired volume for each fraction, within the defined fraction vial volume. The manual fraction control and the option to use the KNAUER electric valves for fractionation gives you more flexibility. The combination of virtual detector and virtual fraction collector allows for optimizing the fractionation settings from an existing chromatogram of your separations without any physically existing device and, therefore, without the loss of solvent or target substance.

Mobile Control (Chrom)

The hand-held Mobile Control (Chrom) allows a complete overview of all devices of the AZURA systems on one screen. Remotely check important parameters or control and monitor devices. The touch-optimized user interface facilitates navigation using just your fingers. The display software Mobile Control provides full access to AZURA devices. Change device settings, set operating parameters, automate device control or check the system status and GLP data... Mobile Control features all functionalities of a device display.

Do you want to acquire data without the overhead of a chromatographic data system? Mobile Control Chrom features data acquisition from AZURA detectors in addition to full device control. Basic purification tasks can be addressed by the function for threshold based fraction collection. Depending on the value of the detector signal, the target substances are automatically collected in different vessels. For each fraction collection block in a program an individual fraction volume can be defined. Choose Mobile Control as a basic, easy-to-use and cost-effective software solution!







Chromeleon™ 7









Chromeleon is one of the most wide-spread chromatography data systems. It offers a broad range of third-party drivers and can be easily used with existing HPLC systems. Chromeleon drivers for many KNAUER devices are available.



Accessories

Improve system performance, organize your lab bench, and work more conveniently with the right accessories.

Accessory	Features	Benefit
Pump head inlet 	<ul style="list-style-type: none"> Connect one 1/4" tube to the AZURA Pump P2.1L Adapters for other diameters available 	For high flow rates and viscous eluent
Mass flow controller 	<ul style="list-style-type: none"> Unmatched accuracy at flow rates up to 833 ml/min Compatible with PurityChrom® 	Precisely monitor the eluent flow
Dynamic Mixing Chamber 	<ul style="list-style-type: none"> Effective homogenization of eluents Choose 1/16" version for flowrates up to 100 ml/min Choose 1/8" version for flowrates above 100 ml/min 	Better performance
VariLoop 	<ul style="list-style-type: none"> Variable injection volume and multiple injections 	Adapt the sample volume to your application
Interface Box IFU 2.1 LAN 	<ul style="list-style-type: none"> Highly precise analog data acquisition 4-channel input/output Sample rates of up to 50 Hz (one channel only) 	Add any detector with analog output to your system
Pulse Damper 	<ul style="list-style-type: none"> high damping performance membrane-free assembly easy implementation into the HPLC system 	<ul style="list-style-type: none"> reduces pulsation improves performance

Accessory	Features	Benefit
Column Base 	<ul style="list-style-type: none"> Holds up to three preparative columns 	Flexible operation with up to three columns
Benchtop Rack 	<ul style="list-style-type: none"> Install AZURA systems at space-limited sites, especially in cold rooms. 	Space-saving solution for AZURA system setup
HPLC system table 	<ul style="list-style-type: none"> Holds 4 AZURA L devices and one fraction collector or alternatively 8 AZURA L devices 	Mobile and compact arrangement of a preparative HPLC system
Air Sensor 	<ul style="list-style-type: none"> Detect end of buffer or end of sample with PurityChrom® Up to four air sensors per system For transparent tubings with 1/16" or 1/8" or 1/4" outer diameter 	Protect column from air damage and support automation (e.g. sample injection)
AZURA® Click 	<ul style="list-style-type: none"> Attach air sensor, pressure control, AZURA Organizer or your interface box to the side panel of your AZURA L device 	Organize your system.
AZURA® Organizer 	<ul style="list-style-type: none"> Attach columns from 5 mm to 26 mm diameter, falcon tubes, pH flow cell 	Organize accessories directly at the system and reduce dead volume
Flow Splitter 	<ul style="list-style-type: none"> Adjustable valve for precise direct control over split ratios Ultra low dead volume fluidic design 	Collect fractions while using your preferred detection method
AZURA® L tubing guide 	<ul style="list-style-type: none"> Single-sided of AZURA L device 2 rows with each 16 holes For 1/8" und 1/16" capillaries 	Sort the capillaries coming from the fraction collection valve

AZURA® Compact Prep HPLC System

The AZURA® Prep Compact system is the perfect start into preparative chromatography. With the complete, semi-preparative HPLC system you master your isocratic purification tasks.

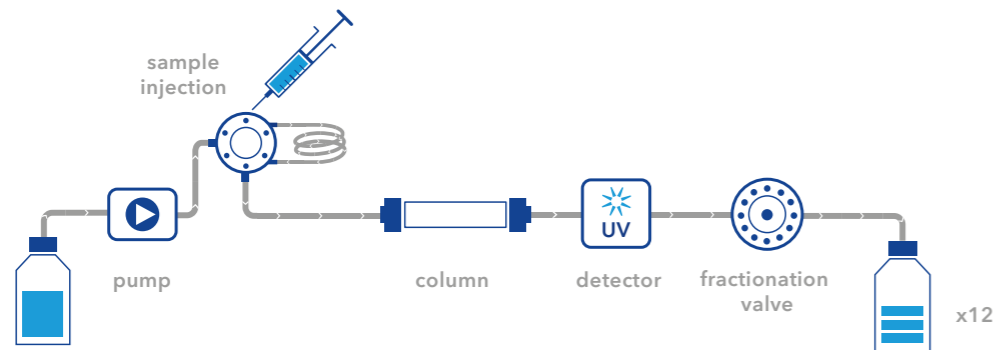

Compact Prep System

One manual injection can purify several hundred milligrams at up to 50 ml/min. Detection takes place via a versatile UV/VIS detector. The intuitive preparative software PurityChrom controls the compact

system and regulates the fraction collection via a 12-port fractionating valve. Thanks to its compact design, the AZURA Prep Compact system finds its place in every laboratory.

- Complete **semi-preparative** isocratic HPLC system with **low space** requirements
- Injection valve incl. **500 µl sample loop**
- **UV/VIS detector** with one variable wavelength
- Intuitive **PurityChrom®** software
- **Compact** and **expandable**



Easy upgrade without big investment

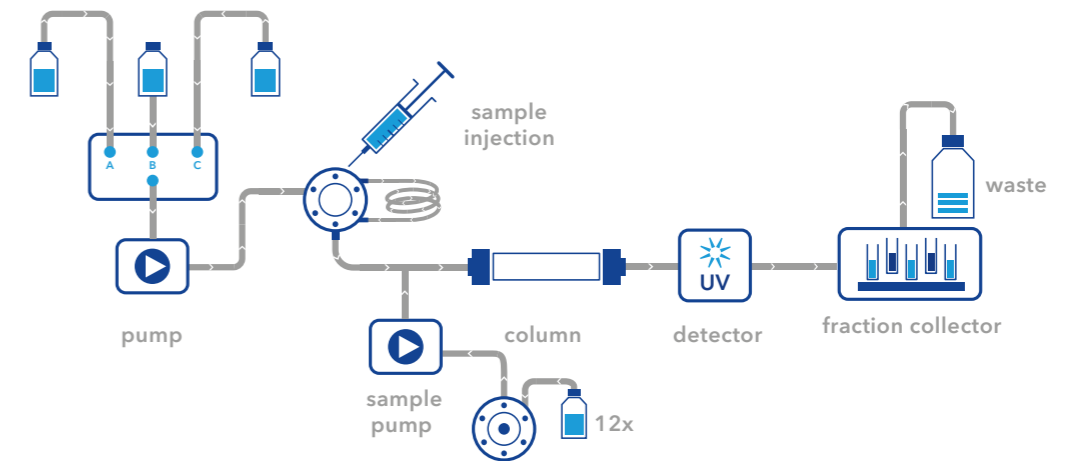

Pilot Prep System

After starting preparative chromatography with the space-saving prep system, the requirements for your purification tasks can quickly increase. The existing Compact System (50 ml/min) can be

expanded to a Pilot System (220 ml/min) by investing in a fraction collector and a preparative pump. All components of the Compact System are fully integrated into the Pilot System.

- Pilot Ternary gradient HPLC system
- Injection valve incl. **500 µl sample loop**
- **Sample pump with automatic sample selection**
- **UV/VIS detector** with one variable wavelength
- Intuitive **PurityChrom®** software
- **Fraction collector**

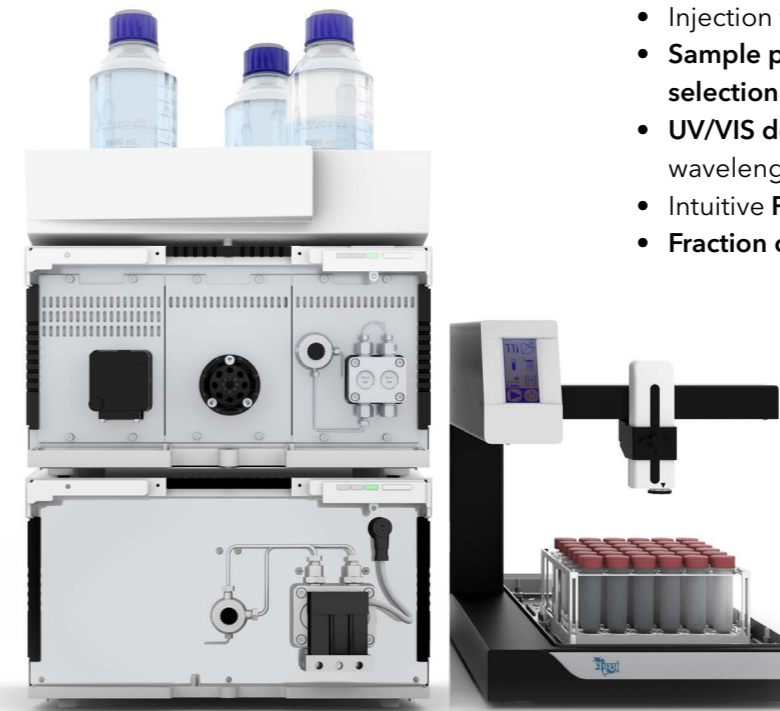

AZURA® Lab Prep HPLC System

The Lab Prep LC system is designed for your more demanding semi-preparative separations. You can customize a highly flexible LC system with the freely combinable components. With a maximum flow rate of 50 ml/min it is possible to separate up to several hundred milligrams per run.

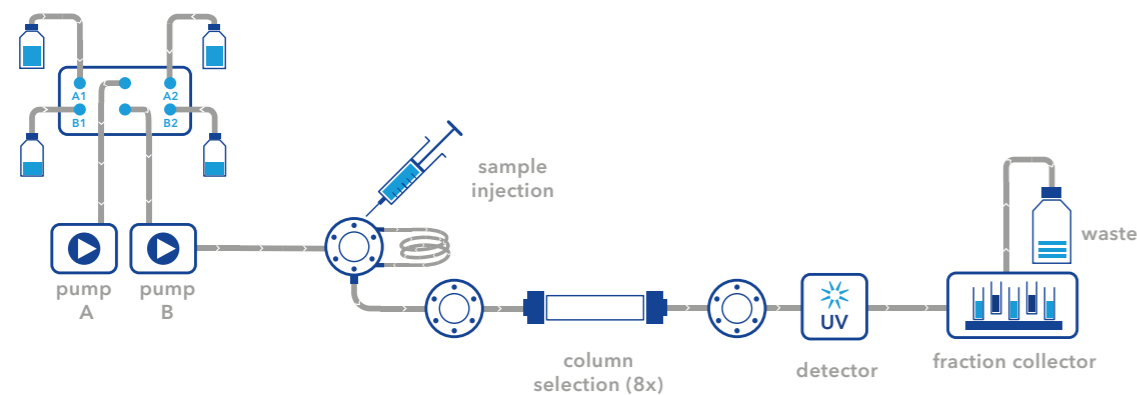

- Lab Prep HPLC system with **binary high pressure gradient**
- **Column selection**
- Injection valve incl. **500 µl sample loop**
- **UV/VIS detector** with one variable wavelength
- Intuitive **PurityChrom®** software
- **Fraction collector**



Method transfer from analysis of chamazulen to preparative scale

Chamomile plants are known for their medical properties, having among others anti-inflammatory, analgesic and sedative effects. These are due to the various phenolic compounds, one of them matricine is converted during the distillation process to chamazulene. The characteristic blue

color of chamomile essential oils as "chamomile blue" is due to chamazulene. It has anti-inflammatory and anti-oxidant activity. The present application tested preparative HPLC to purify chamazulene from commercially available "chamomile blue" oil.

Results

Fractionation/Purification

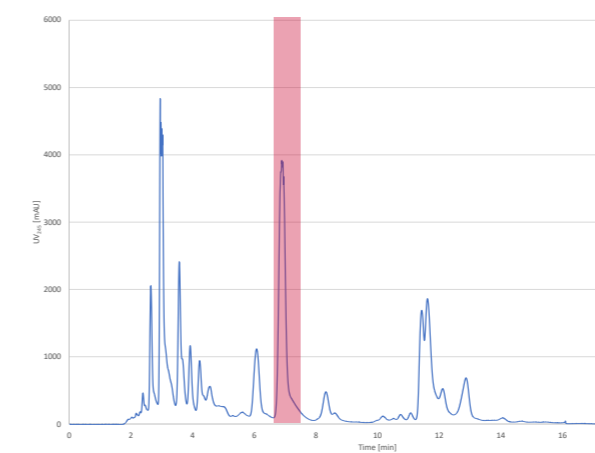

Fig. 1: Chromatogramm of preparative separation of chamazulene blue, collected fraction highlighted in red, 1 ml sample injection

Fraction analysis

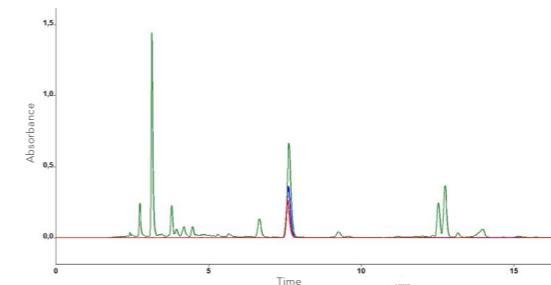

Fig. 2: Chromatogram overlay

The separation of chamazulene was optimized in analytical scale and the two step gradient method transferred to preparative scale. Chamazulene purification was performed on C18 250x20 mm column, 25 ml/min. Fractionation of chamazulene was conducted by threshold function of PurityChrom software.

The collected fraction was analysed by analytical HPLC and revealed nearly 100 % purity. Chromatogram overlay of the fraction, chamazulene standard and the sample clearly showed the successful purification of chamazulene (Fig. 2). Further the comparison of the fraction spectra and chamazulene spectra (Fig. 3) revealed that the purified fraction was chamazulene.

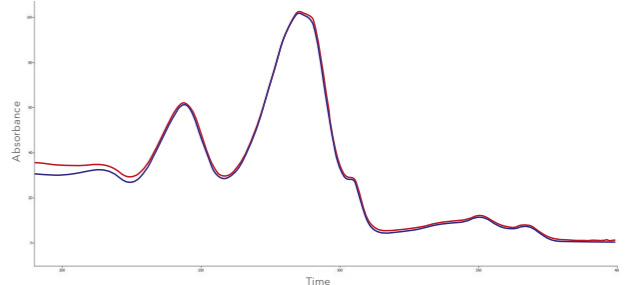

Fig. 3: Spectral view of fraction (-) and of chamazulene standard (-)

Application Note (VPH0071)

Purification of chamazulene by preparative HPLC and its scale-up
www.knauer.net/applications



AZURA® Pilot Prep HPLC System

Choose the Pilot Prep LC system if you want to increase your productivity even more. As for the AZURA Lab Prep LC system you can freely build up your system. Flow rates up to 1 000 ml/min and loads up to several grams are possible. Optional peak and solvent recycling can be set up to increase separation power and reduce separation costs significantly.

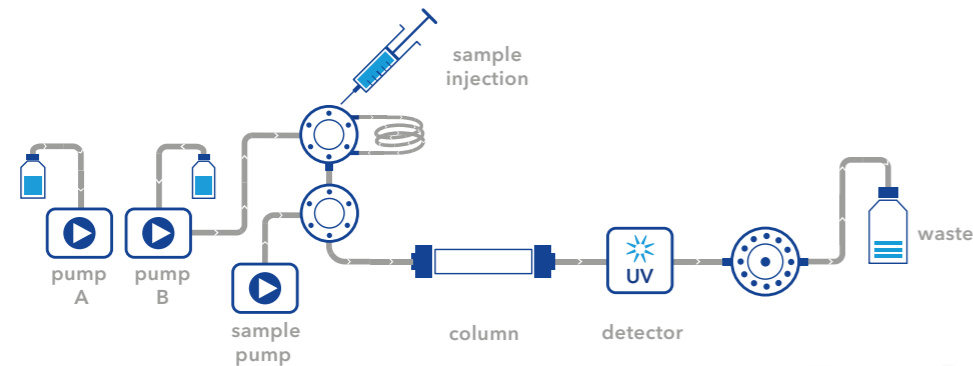

- Pilot Prep HPLC system with **binary high pressure gradient**
- **Sample pump**
- Injection valve
- **UV/VIS detector** with one variable wavelength
- **12 Port** fractionation valve
- Intuitive **PurityChrom®** software



Improved purity by combining online SPE with preparative LC

Steviol glycosides are the main sweetening compounds in Stevia rebaudiana and are often used as natural sugar substitutes. To enable a commercial usage, the plant extracts need to be purified. In this work preparative online SPE (solid phase extraction) with the AZURA Pilot Prep LC was investigated for improvement of overall purity due to reduction of matrix contamination.

The steviol glycoside rebaudioside A is the main compound of interest as it is the sweetest and less bitter compound of the extract. Often Stevia products contain a mixture of rebaudioside A and stevioside. The development of a purification method with high yield of rebaudioside A, only few stevioside impurities, and high throughput increases the economic output of Stevia production.

Results

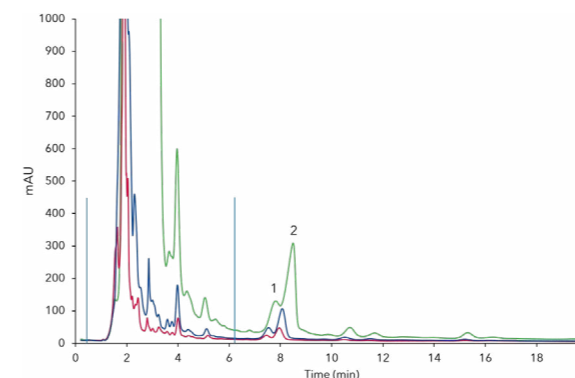

Overload experiments on preparative column, 200 µL (red), 500 µL (blue), 2000 µL (green); 1) rebaudioside A, 2) stevioside, blue bars - matrix, 25°C, 22 ml/min

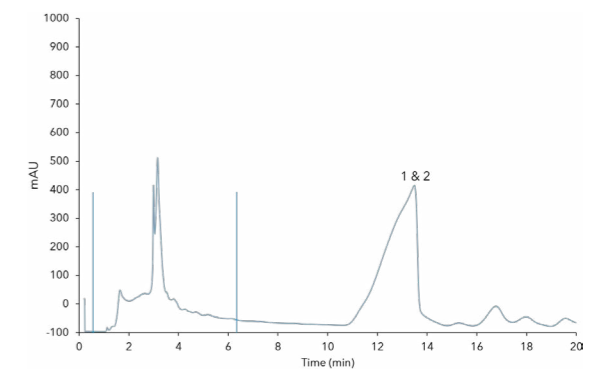

Preparative online SPE, 10 mL loading; 1) rebaudioside A, 2) stevioside, blue bars - matrix, 25°C, 22 mL/min

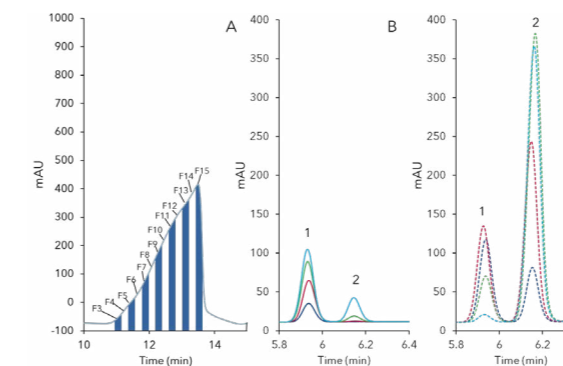

Fraction analysis of preparative online-SPE purification (Fig.2) of rebaudioside A (1) and stevioside (2); a) F3 (blue), F4 (red), F5 (green), F6 (light blue); b) F7 (red dashed), F10 (blue dashed), F12 (green dashed), F15 (light blue dashed); c) fractionation of target peak, 5 mL fractions

Fig. 1 shows the batch LC without online SPE. The matrix peak (1-5min) negatively affect the separation abilities. In comparison Fig 2 shows that the automated SPE process significantly decreased the matrix. The fraction analysis revealed that only a small part of the overlapping peak contained nearly pure rebaudioside A; fractions 3-5 approx. 15 mL with >90 % rebaudioside A and <10% stevioside (Fig. 3, B). The later fractions contained high amounts of stevioside but also still rebaudioside A (Fig. 3 C). The results showed that purification of highly pure rebaudioside A is possible by an additional online-SPE .

Application Note (VFD0171)

Evaluating preparative online SPE for the purification of stevia leave extracts
www.knauer.net/applications



Preparative HPLC for cannabinoid purification

Whenever highly pure cannabinoids should be produced from Cannabis plants or raw extracts, preparative chromatography is the most versatile method to choose. Take a look at the exemplary developed method to purify cannabidiol (CBD) from CBD oil.

Cannabis Purifier

Purification of single cannabinoids from extracts of cannabis flos or cannabinoid oil.

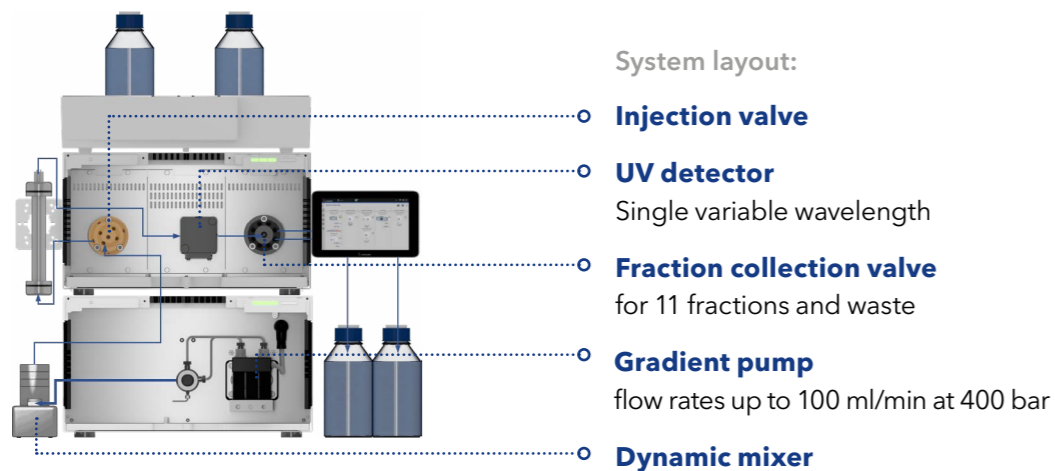

Easy scale-up by changing the pump head, valves, flow cell, and capillaries. No exchange of devices necessary.

SMB for cannabinoid purification

Whether to favor batch LC or a continuous process like simulated moving bed (SMB) chromatography, depends on the specific customer's needs. KNAUER has extensive experiences in customized solutions for both types of applications for the cannabis industry.

More information

For more information about analyzing and purifying Cannabis:
www.knauer.net/cannabis



AZURA® SMB systems



Simulated moving bed chromatography (SMBC) is increasingly applied as a separation technique in the pharmaceutical industry, production of fine chemicals and in the field of bioengineering. SMB is a method in process chromatography that enables substance mixtures to be continuously separated and extracted in two fractions. By repeated use of the SMB process each partial fraction can be separated into a further fraction - down to binary substance mixtures. Typically, the SMB process is set up in advance for a two component mixture. Following this, both substances can be immediately extracted in pure form.

For more information about SMB:
www.knauer.net/smb

What is the difference between batch LC and SMBC?

Batch chromatography (single-column)	SMB chromatography (multi-column)
Unlimited number of fractions	Two fractions, no waste
Recovery typically below 80%	Recovery up to 100%
EITHER high purity OR high yield	High purity AND high yield
Isocratic or gradient	Isocratic
High solvent consumption	Can be as low as 10% of batch consumption
Very diluted product	Product concentration comparable with input concentration (feed)

Science with Passion



Based in Berlin, KNAUER is a medium-sized, owner-managed company that has been serving the sciences since 1962. We develop and manufacture scientific instruments of superior quality for liquid chromatography. The range



Worldwide partner in science since 1962

includes systems and components for analytical HPLC / UHPLC, preparative HPLC, fast protein liquid chromatography (FPLC), multi-column chromatography / simulated moving bed (SMB), and osmometry.

Independent and family owned



The founder Dr. Herbert Knauer and his wife Roswitha are still active as advisers in the company to this day. The couple's daughter, Alexandra Knauer, has been managing director and owner

of the company since 2000. Several awards for outstanding products and innovations as well as entrepreneurial excellence make KNAUER a „leading employer“.

THAT'S WHAT A CUSTOMER SAYS

“At Numaferm, we use proprietary recombinant technologies to identify, optimize and produce peptides. Our customers receive peptides of the highest quality at significantly reduced production costs, being produced sustainable. As an ISO 9001:2015 certified company, reliability and customer satisfaction are our top priorities. We have been working together with KNAUER for many years and successfully use the HPLC systems for purification.”

Dr. Hilke Wobst

Head Downstream Processing & Analytics
Numaferm GmbH



System configurator Preparative HPLC by KNAUER

MAKE YOUR PRESELECTION

Stainless steel

Biocompatible

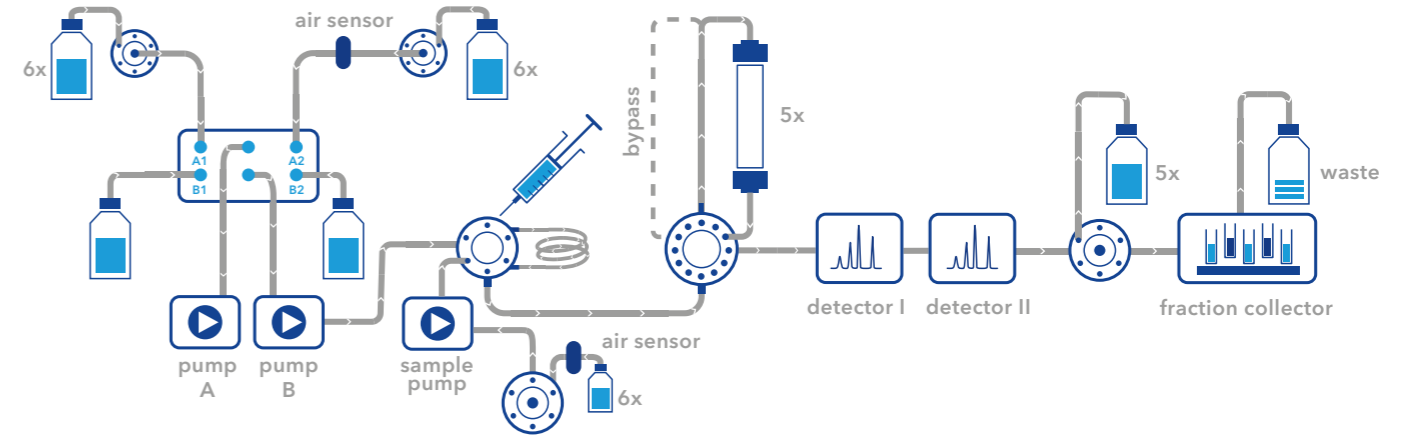

SOLVENT SELECTION & DELIVERY

- 50 ml/min binary gradient pump P 6.1L
- x 100 ml/min pump P 2.1L
- x 250 ml/min pump P 2.1L
- x 500 ml/min pump P 2.1L
- x 1000 ml/min pump P 2.1L
- Ternary gradient module for pump P 2.1L
- Binary gradient module for pump P 2.1L
- x solvent selection valve

SAMPLE INJECTION

- Injection valve
- Sample pump module
- Sample selection valve: x inlets
- Autosampler AS 6.1L

COLUMN SELECTION & THERMOSTAT

- Column selection (two columns or one bypass)
- Column selection high flow (5 columns, one bypass)

DETECTION

- UV/VIS single wavelength
- UV/VIS multiwave length
- DAD 2.1L
- Conductivity
- pH
- Refractive index
- Light Scattering
- 4000 MiD
- A/D-converter (integration of further detectors)

FRACTION COLLECTION

- LABOCOL fraction collector with individual rack types
- KNAUER Liquid Handler 2.1
- Foxy fraction collector with fixed rack types
- Fractionation valve
- Rack for fraction collector
- Flow splitter

ACCESSORIES

- x Airsensor main pump
- x Tubing 1/16"
- x Airsensor feed pump
- x Tubing 1/8"
- Mass flow controller
- x Tubing 1/4"
- AZURA Click
- Workstation (Windows)
- AZURA Organizer

SOFTWARE

- ClarityChrom®
- Chromeleon™
- OpenLAB®
- Mobile Control
- PurityChrom®

COMMON APPLICATIONS

- Reversed phase
- other...
- Normal phase
- System Qualification

Disclaimer: Technical data or prices are subject to change without notice. Prices may vary by country and do not include taxes, customs duties or delivery. All trademarks are the property of their respective owners. Our general terms and conditions apply: www.knauer.net/terms.

KNAUER is the proud winner of the German Innovation Award 2022 in the category of medium-sized businesses.

(U)HPLC • FPLC • SMB • Osmometry and units for the production of lipid nanoparticles (LNP)



Innovation

Own hardware and software development



Customized solutions

Pumps, detectors, valves and systems adapted to your needs



Made in Germany

Independent and family-owned since 1962

think **LC.** think **KNAUER.**

KNAUER Wissenschaftliche Geräte GmbH

Hegauer Weg 38 • 14163 Berlin
+49 30 809727-0 • +49 30 8015010 (Fax)
info@knauer.net • www.knauer.net

